

**TOOL HOLDER**

---

**ACCESSORY**

## ACCESSORY

### 附件

Morse Taper ER Collet Chuck.....	M.04
莫氏柄ER刀柄.....	M.04
Morse Taper OZ Collet Chuck.....	M.06
莫氏柄OZ刀柄 .....	M.06
Morse Taper Face Mill Holder .....	M.07
莫氏柄面铣刀柄.....	M.07
Morse Taper Combi Shell Mill Holder .....	M.08
莫氏柄混合插入式铣刀柄 .....	M.08
Morse Taper Tapping Chuck .....	M.08
莫氏柄攻丝刀柄 .....	M.08
ER Collet Chuck with Mini Nut.....	M.09
ER 弹簧夹头刀柄 .....	M.09
Straight Shank Tapping Chuck .....	M.12
弹性快换攻丝刀柄.....	M.12
ER Collet .....	M.13
ER 筒夹 .....	M.13
ER Collet Set .....	M.18
ER 筒夹套装 .....	M.18
ER Sealed Collet .....	M.19
ER 止水筒夹.....	M.19
ER Tapping Collet .....	M.23
ER 攻丝筒夹.....	M.23
ER Tapping Sealed Collet .....	M.24
ER 止水攻丝筒夹.....	M.24
Straight Shank Collet .....	M.25
SC 直柄筒夹 .....	M.25
OZ Collet .....	M.26
OZ 筒夹 .....	M.26
SKS Collet.....	M.28
SKS 筒夹.....	M.28
DC Collet.....	M.30
DC 后拉筒夹.....	M.30
Tapping Collet.....	M.32
攻丝筒夹.....	M.32
BT Pull Stud.....	M.36
BT 拉钉.....	M.36
SK Pull Stud .....	M.37
SK 拉钉 .....	M.37
ISO 7388 Pull Stud .....	M.37
ISO 7388拉钉 .....	M.37
CAT Pull Stud .....	M.38
CAT 拉钉 .....	M.38
OTT Pull Stud .....	M.38
OTT 拉钉 .....	M.38
ISO Pull Stud .....	M.39
ISO 拉钉 .....	M.39
Mazak Pull Stud .....	M.39
马扎克拉钉 .....	M.39



## ACCESSORY 附件

ER Nut .....	M.40
ER 压帽 .....	M.40
ER Sealed Nut .....	M.42
ERS 止水压帽 .....	M.42
Sealing Disc .....	M.42
止水垫圈 .....	M.42
OZ Nut .....	M.43
OZ 压帽 .....	M.43
SKS Nut .....	M.43
SKS 压帽 .....	M.43
ER Spanner .....	M.44
ER 扳手 .....	M.44
Hook Spanner .....	M.46
勾头扳手 .....	M.46
Ball Spanner .....	M.46
滚珠扳手 .....	M.46
Boring Bar Sleeve .....	M.47
车床刀套（公制） .....	M.47
B Bushing .....	M.48
车床刀套B型 .....	M.48
J Bushing .....	M.49
车床刀套J型 .....	M.49
C Bushing .....	M.51
车床刀套C型 .....	M.51
CV Bushing .....	M.53
车床刀套CV型 .....	M.53
DD Bushing .....	M.54
车床刀套DD型 .....	M.54
Z Bushing .....	M.55
车床刀套Z型 .....	M.55
Locking Device.....	M.58
锁刀座 .....	M.58
HSK Coolant Tube .....	M.59
HSK 冷却导管 .....	M.59
Balluff Data Carrier.....	M.59
巴鲁夫数据芯片 .....	M.59
Clamping Kit .....	M.60
组合压板 .....	M.60
Tool Holder Trolley .....	M.61
刀具车 .....	M.61
Tool Holder Cleaning Device.....	M.64
除锈机 .....	M.64



## ER Collet Chuck with UM Nut

### ER 弹簧夹头刀柄

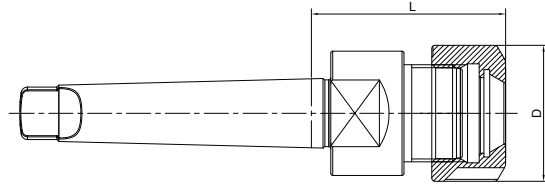

Size	D	L	Capacity
MTA2-ER25-60	42	60	2-16
MTA2-ER32-60	50	60	2-20
MTA3-ER25-60	42	60	2-16
MTA3-ER32-70	50	70	2-20
MTA3-ER40-80	63	80	3-26
MTA4-ER25-60	42	60	2-16
MTA4-ER32-70	50	70	2-20
MTA4-ER40-80	63	80	3-26
MTA5-ER40-80	63	80	3-26

## ER Collet Chuck with Mini Nut

### ER 弹簧夹头刀柄

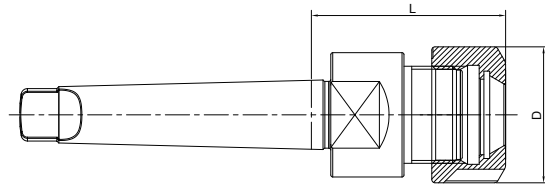

Size	D	L	Capacity
MTA2-ER16M-50	22	50	1-10
MTA2-ER20M-50	28	50	1-13
MTA3-ER16M-60	22	60	1-10
MTA3-ER20M-60	28	60	1-13



**ER Collet Chuck DIN6499**  
**ER 弹簧夹头刀柄**

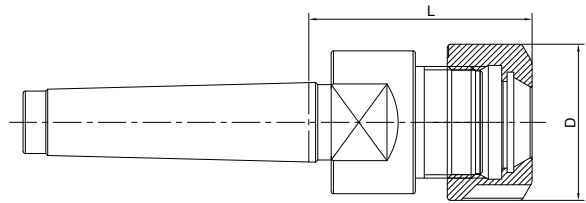

Size	D	L	Capacity
MTB1-ER11A-30	19	30	1-7
MTB1-ER16A-40	28	40	1-10
MTB2-ER16M-50	22	50	1-10
MTB2-ER20M-50	28	50	1-13
MTB2-ER11A-30	19	30	1-7
MTB2-ER16A-50	28	50	1-10
MTB2-ER20A-50	34	50	1-13
MTB2-ER25-47	42	47	2-16
MTB2-ER32-75	50	75	2-20
MTB2-ER40-80	63	80	3-26
MTB3-ER16M-60	22	60	1-10
MTB3-ER20M-50	28	50	1-13
MTB3-ER16A-50	28	50	1-10
MTB3-ER20A-50	36	50	1-13
MTB3-ER25-56	42	56	2-16
MTB3-ER32-60	50	60	2-20
MTB3-ER40-80	63	80	3-26
MTB4-ER25-60	42	60	2-16
MTB4-ER32-60	50	60	2-20
MTB4-ER40-80	63	80	3-26
MTB4-ER50-80	78	80	6-34
MTB5-ER40-80	63	80	3-26
MTB5-ER50-80	78	80	6-34

## OZ Collet Chuck DIN6391

### OZ 夹头刀柄

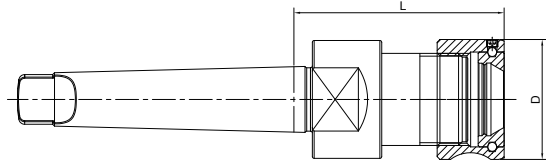

Size	D	L	Capacity
MTA2-OZ25-70	60	70	3-25
MTA3-OZ25-70	60	70	3-25
MTA4-OZ25-70	60	70	3-25

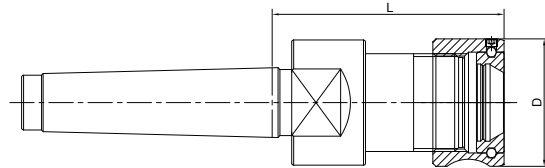

Size	D	L	Capacity
MTB2-OZ25-70	60	70	3-25
MTB3-OZ25-70	60	70	3-25
MTB4-OZ25-70	60	70	3-25
MTB4-OZ32-80	72	80	6-32
MTB5-OZ25-75	60	75	3-25
MTB5-OZ32-80	72	80	6-32

**Face Mill Holder DIN6357**  
面铣刀柄

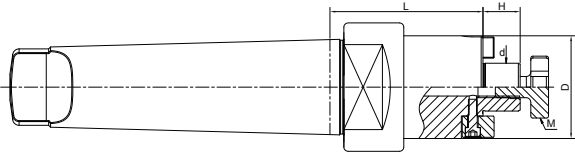

Size	d	D	L	H	M
MTA2-FMB16-30	16	38	30	17	M8
MTA2-FMB22-30	22	48	30	19	M10
MTA2-FMB27-30	27	58	30	21	M12
MTA3-FMB16-30	16	38	30	17	M8
MTA3-FMB22-30	22	48	30	19	M10
MTA3-FMB27-30	27	58	30	21	M12
MTA3-FMB32-30	32	78	30	24	M16
MTA4-FMB16-32	16	38	32	17	M8
MTA4-FMB22-32	22	48	32	19	M10
MTA4-FMB27-32	27	58	32	21	M12
MTA4-FMB32-32	32	78	32	24	M16
MTA4-FMB40-32	40	88	32	27	M20

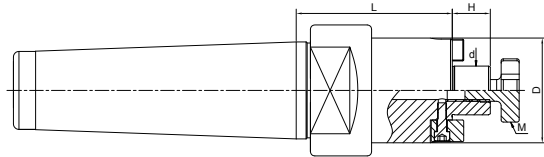

Size	d	D	L	H	M
MTB3-FMB16-48	16	38	48	17	M8
MTB3-FMB22-48	22	48	48	19	M10
MTB3-FMB27-48	27	58	48	21	M12
MTB3-FMB32-48	32	78	48	24	M16
MTB3-FMB40-48	40	88	48	27	M20
MTB4-FMB22-55	22	48	55	19	M10
MTB4-FMB27-55	27	58	55	21	M12
MTB4-FMB32-55	32	78	55	24	M16
MTB4-FMB40-55	40	88	55	27	M20

## Combi Shell Mill Holder DIN6358

### 混合插入式铣刀柄

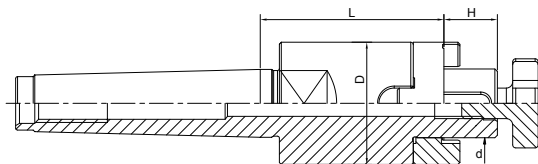

Size	d	D	H	L
MTB2-SEMC16-48	16	32	17	48
MTB2-SEMC22-48	22	40	19	48
MTB2-SEMC27-55	27	48	21	55
MTB2-SEMC32-55	32	58	24	55
MTB3-SEMC16-48	16	32	17	48
MTB3-SEMC22-50	22	40	19	50
MTB3-SEMC27-55	27	48	21	55
MTB3-SEMC32-55	32	58	24	55
MTB4-SEMC16-55	16	32	17	55
MTB4-SEMC22-55	22	40	19	55
MTB4-SEMC27-55	27	48	21	55
MTB4-SEMC32-55	32	58	24	55

## Quick Change Tapping Chuck with Length Compensation

### 弹性快换攻丝刀柄

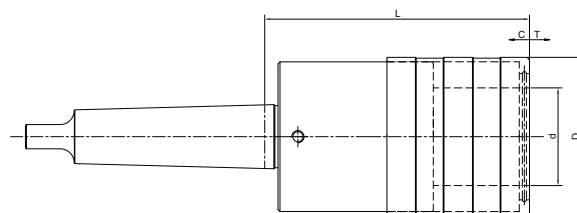

Size	D	d	L	T	C
MTA2-TC312-46	36	19	46	7.5	7.5
MTA3-TC312-46	36	19	46	7.5	7.5
MTA3-TC820-68	53	31	68	12.5	12.5
MTA4-TC820-70	35	31	70	12.5	12.5
MTA4-TC1433-108	78	48	108	22	22
MTA5-TC1433-103	78	48	103	22	22

## ER Collet Chuck with Mini Nut DIN6499

### ER 弹簧夹头刀柄

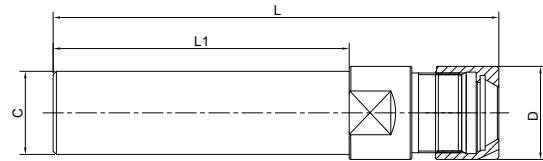

#### Metric

Size	C	D	L1	L
C8-ER8M-100	08	12	100	124.5
C10-ER8M-100	10	12	100	124.5
C10-ER8M-150	10	12	150	174.5
C12-ER11M-100	12	16	100	125
C16-ER11M-100	16	16	100	125
C16-ER11M-150	16	16	150	175
C16-ER16M-100	16	22	100	131
C16-ER16M-150	16	22	150	181
C20-ER16M-100	20	22	100	131
C20-ER16M-150	20	22	150	181
C20-ER20M-100	20	28	100	137
C20-ER20M-150	20	28	150	187
C25-ER16M-100	25	22	100	131
C25-ER16M-150	25	22	150	181
C25-ER20M-100	25	28	100	137
C25-ER20M-150	25	28	150	187

#### Inch

Size	C	D	L1	L
C1/2"-ER11M-4.0"	1/2"	16	4"	126.6
C1/2"-ER11M-6.0"	1/2"	16	6"	177.4
C1/2"-ER16M-4.0"	1/2"	22	4"	132.6
C1/2"-ER16M-6.0"	1/2"	22	6"	183.4

## ER Collet Chuck with Hex Nut DIN6499

### ER 弹簧夹头刀柄

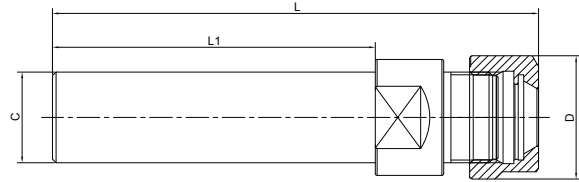

#### Metric

Size	C	D	L1	L
C10-ER8A-100	10	13.3	100	124.5
C10-ER11A-100	10	19	100	124
C12-ER8A-100	12	13.3	100	124.5
C12-ER11A-100	12	19	100	124
C16-ER11A-50	16	19	50	74
C16-ER11A-100	16	19	100	124
C16A-ER16A-100	16	28	100	131
C16A-ER16A-150	16	28	150	181
C20-ER16A-100	20	28	100	131
C20-ER16A-150	20	28	150	181
C20-ER20A-100	20	34	100	136.5
C20-ER20A-150	20	34	150	186.5
C25-ER16A-100	25	28	100	136.5
C25-ER16A-150	25	28	150	186.5
C25-ER20A-100	25	34	100	136.5
C25-ER20A-150	25	34	150	186.5

#### Inch

Size	C	D	L1	L
C1/2"-ER11A-3.5"	1/2"	19	3.5"	112.9
C1/2"-ER11A-6"	1/2"	19	6"	176.4
C3/4"-ER16A-4"	3/4"	28	4"	132.6
C3/4"-ER16A-6"	3/4"	28	6"	183.4
C3/4"-ER20A-4"	3/4"	34	4"	138.6
C3/4"-ER20A-6"	3/4"	34	6"	189.4

## ER Collet Chuck with UM Nut DIN6499

### ER 弹簧夹头刀柄

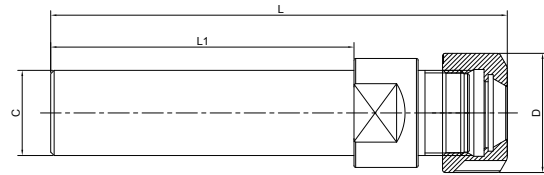

#### Metric

Size	C	D	L1	L
C20-ER25UM-100	20	42	100	144
C25-ER25UM-100	25	42	100	144
C25-ER25UM-150	25	42	150	194
C25-ER25UM-200	25	42	200	244
C25-ER32UM-100	25	50	100	148
C32-ER25UM-100	32	42	100	144
C32-ER25UM-150	32	42	150	194
C32-ER32UM-100	32	50	100	148
C32-ER32UM-150	32	50	150	198
C32-ER32UM-200	32	50	200	248
C32-ER40UM-100	32	63	100	151
C40-ER32UM-100	40	50	100	148
C40-ER40UM-100	40	63	100	151
C40-ER40UM-150	40	63	150	201

#### Inch

Size	C	D	L1	L
C3/4"-ER25-4"	3/4"	42	4"	145.6
C1"-ER25-6"	1"	42	6"	196.4
C1"-ER32-4"	1"	50	4"	149.6
C1-1/4"-ER32-6"	1-1/4"	50	6"	200.4

## Quick Change Tapping Chuck with Length Compensation

### 弹性快换攻丝刀柄

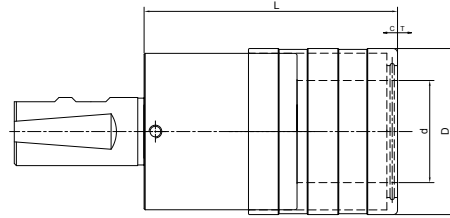

Size	L	D	d	T	C
SLAB20-TC312-41	41	36	19	7.5	7.5
SLAB25-TC312-41	41	36	19	7.5	7.5
SLAB25-TC820-63	63	53	31	12.5	12.5
SLAB32-TC312-41	41	36	19	7.5	7.5
SLAB32-TC820-63	63	53	31	12.5	12.5
SLAB32-TC1433-97	97	78	48	22	22
SLAB40-TC312-41	41	36	19	7.5	7.5
SLAB40-TC820-63	63	53	31	12.5	12.5
SLAB40-TC1433-97	97	78	48	22	22



## ER Collet ER 弹簧夹头

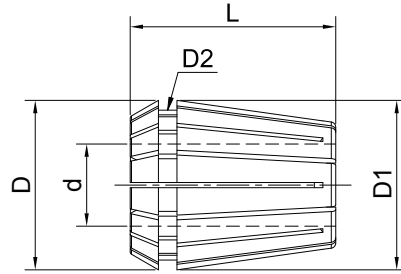

### Metric

Size	d	D1	D	D2	L
ER8-01	1-0.5	8	8.45	6.5	13.5
ER8-01.5	1.5-1	8	8.45	6.5	13.5
ER8-02	2-1.5	8	8.45	6.5	13.5
ER8-02.5	2.5-2	8	8.45	6.5	13.5
ER8-03	3-2.5	8	8.45	6.5	13.5
ER8-03.5	3.5-3	8	8.45	6.5	13.5
ER8-04	4-3.5	8	8.45	6.5	13.5
ER8-04.5	4.5-4	8	8.45	6.5	13.5
ER8-05	5-4.5	8	8.45	6.5	13.5

ER11-01	1-0.5	11	11.5	9.5	18
ER11-01.5	1.5-1	11	11.5	9.5	18
ER11-02	2-1.5	11	11.5	9.5	18
ER11-02.5	2.5-2	11	11.5	9.5	18
ER11-03	3-2.5	11	11.5	9.5	18
ER11-03.5	3.5-3	11	11.5	9.5	18
ER11-04	4-3.5	11	11.5	9.5	18
ER11-04.5	4.5-4	11	11.5	9.5	18
ER11-05	5-4.5	11	11.5	9.5	18
ER11-05.5	5.5-5	11	11.5	9.5	18
ER11-06	6-5.5	11	11.5	9.5	18
ER11-06.5	6.5-6	11	11.5	9.5	18
ER11-07	7-6.5	11	11.5	9.5	18

ER16-01	1-0.5	16	17	13.8	27.5
ER16-02	2-1	16	17	13.8	27.5
ER16-03	3-2	16	17	13.8	27.5
ER16-04	4-3	16	17	13.8	27.5
ER16-05	5-4	16	17	13.8	27.5
ER16-06	6-5	16	17	13.8	27.5
ER16-07	7-6	16	17	13.8	27.5
ER16-08	8-7	16	17	13.8	27.5
ER16-09	9-8	16	17	13.8	27.5
ER16-10	10-9	16	17	13.8	27.5

Size	d	D1	D	D2	L
ER20-01	1-0.5	20	21	17.4	31.5
ER20-02	2-1	20	21	17.4	31.5
ER20-03	3-2	20	21	17.4	31.5
ER20-04	4-3	20	21	17.4	31.5
ER20-05	5-4	20	21	17.4	31.5
ER20-06	6-5	20	21	17.4	31.5
ER20-07	7-6	20	21	17.4	31.5
ER20-08	8-7	20	21	17.4	31.5
ER20-09	9-8	20	21	17.4	31.5
ER20-10	10-9	20	21	17.4	31.5
ER20-11	11-10	20	21	17.4	31.5
ER20-12	12-11	20	21	17.4	31.5
ER20-13	13-12	20	21	17.4	31.5

ER25-01	1-0.5	25	26	22	34
ER25-02	2-1	25	26	22	34
ER25-03	3-2	25	26	22	34
ER25-04	4-3	25	26	22	34
ER25-05	5-4	25	26	22	34
ER25-06	6-5	25	26	22	34
ER25-07	7-6	25	26	22	34
ER25-08	8-7	25	26	22	34
ER25-09	9-8	25	26	22	34
ER25-10	10-9	25	26	22	34
ER25-11	11-10	25	26	22	34
ER25-12	12-11	25	26	22	34
ER25-13	13-12	25	26	22	34
ER25-14	14-13	25	26	22	34
ER25-15	15-14	25	26	22	34
ER25-16	16-15	25	26	22	34

## ER Collet

### ER 弹簧夹头

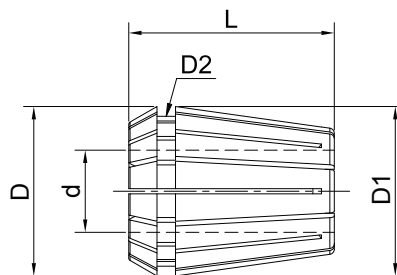

#### Metric

Size	d	D1	D	D2	L
ER32-02	2-1	32	33	29.2	40
ER32-03	3-2	32	33	29.2	40
ER32-04	4-3	32	33	29.2	40
ER32-05	5-4	32	33	29.2	40
ER32-06	6-5	32	33	29.2	40
ER32-07	7-6	32	33	29.2	40
ER32-08	8-7	32	33	29.2	40
ER32-09	9-8	32	33	29.2	40
ER32-10	10-9	32	33	29.2	40
ER32-11	11-10	32	33	29.2	40
ER32-12	12-11	32	33	29.2	40
ER32-13	13-12	32	33	29.2	40
ER32-14	14-13	32	33	29.2	40
ER32-15	15-14	32	33	29.2	40
ER32-16	16-15	32	33	29.2	40
ER32-17	17-16	32	33	29.2	40
ER32-18	18-17	32	33	29.2	40
ER32-19	19-18	32	33	29.2	40
ER32-20	20-19	32	33	29.2	40

ER40-03	3-2	40	41	36.2	46
ER40-04	4-3	40	41	36.2	46
ER40-05	5-4	40	41	36.2	46
ER40-06	6-5	40	41	36.2	46
ER40-07	7-6	40	41	36.2	46
ER40-08	8-7	40	41	36.2	46
ER40-09	9-8	40	41	36.2	46
ER40-10	10-9	40	41	36.2	46
ER40-11	11-10	40	41	36.2	46
ER40-12	12-11	40	41	36.2	46
ER40-13	13-12	40	41	36.2	46

Size	d	D1	D	D2	L
ER40-14	14-13	41	40	36.2	46
ER40-15	15-14	41	40	36.2	46
ER40-16	16-15	41	40	36.2	46
ER40-17	17-16	41	40	36.2	46
ER40-18	18-17	41	40	36.2	46
ER40-19	19-18	41	40	36.2	46
ER40-20	20-19	41	40	36.2	46
ER40-21	21-20	41	40	36.2	46
ER40-22	22-21	41	40	36.2	46
ER40-23	23-22	41	40	36.2	46
ER40-24	24-23	41	40	36.2	46
ER40-25	25-24	41	40	36.2	46
ER40-26	26-25	41	40	36.2	46

ER50-06	6-4	52	50	46	60
ER50-08	8-6	52	50	46	60
ER50-10	10-8	52	50	46	60
ER50-12	12-10	52	50	46	60
ER50-14	14-12	52	50	46	60
ER50-16	16-14	52	50	46	60
ER50-18	18-16	52	50	46	60
ER50-20	20-18	52	50	46	60
ER50-22	22-20	52	50	46	60
ER50-24	24-22	52	50	46	60
ER50-26	26-24	52	50	46	60
ER50-28	28-26	52	50	46	60
ER50-30	30-28	52	50	46	60
ER50-32	32-30	52	50	46	60
ER50-34	34-32	52	50	46	60

## ER Collet ER 弹簧夹头

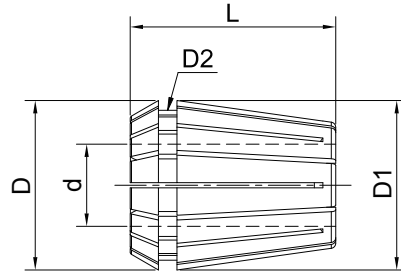
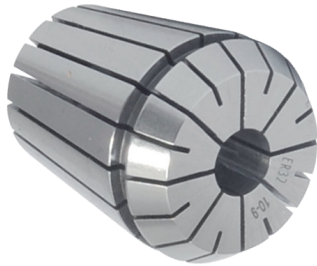

### Metric

Size	d	D1	D	D2	L
ER11-3/64"	3/64	11	11.5	9.5	18
ER11-1/16"	1/16	11	11.5	9.5	18
ER11-5/64"	5/64	11	11.5	9.5	18
ER11-3/32"	3/32	11	11.5	9.5	18
ER11-7/64"	7/64	11	11.5	9.5	18
ER11-1/8"	1/8	11	11.5	9.5	18
ER11-9/64"	9/64	11	11.5	9.5	18
ER11-5/32"	5/32	11	11.5	9.5	18
ER11-11/64"	11/64	11	11.5	9.5	18
ER11-3/16"	3/16	11	11.5	9.5	18
ER11-13/64"	13/64	11	11.5	9.5	18
ER11-7/32"	7/32	11	11.5	9.5	18
ER11-15/64"	15/64	11	11.5	9.5	18
ER11-1/4"	1/4	11	11.5	9.5	18
ER11-17/64"	17/64	11	11.5	9.5	18

ER16-3/64"	3/64	16	17	13.8	27.5
ER16-1/16"	1/16	16	17	13.8	27.5
ER16-5/64"	5/64	16	17	13.8	27.5
ER16-3/32"	3/32	16	17	13.8	27.5
ER16-7/64"	7/64	16	17	13.8	27.5
ER16-1/8"	1/8	16	17	13.8	27.5
ER16-9/64"	9/64	16	17	13.8	27.5
ER16-5/32"	5/32	16	17	13.8	27.5
ER16-11/64"	11/64	16	17	13.8	27.5
ER16-3/16"	3/16	16	17	13.8	27.5
ER16-13/64"	13/64	16	17	13.8	27.5
ER16-7/32"	7/32	16	17	13.8	27.5
ER16-15/64"	15/64	16	17	13.8	27.5
ER16-1/4"	1/4	16	17	13.8	27.5
ER16-17/64"	17/64	16	17	13.8	27.5
ER16-9/32"	9/32	16	17	13.8	27.5
ER16-19/64"	19/64	16	17	13.8	27.5
ER16-5/16"	5/16	16	17	13.8	27.5
ER16-21/64"	21/64	16	17	13.8	27.5

Size	d	D1	D	D2	L
ER16-11/32"	11/32	16	17	13.8	27.5
ER16-23/64"	23/64	16	17	13.8	27.5
ER16-3/8"	3/8	16	17	13.8	27.5

ER20-3/64"	3/64	20	21	17.4	31.5
ER20-1/16"	1/16	20	21	17.4	31.5
ER20-5/64"	5/64	20	21	17.4	31.5
ER20-3/32"	3/32	20	21	17.4	31.5
ER20-7/64"	7/64	20	21	17.4	31.5
ER20-1/8"	1/8	20	21	17.4	31.5
ER20-9/64"	9/64	20	21	17.4	31.5
ER20-5/32"	5/32	20	21	17.4	31.5
ER20-11/64"	11/64	20	21	17.4	31.5
ER20-3/16"	3/16	20	21	17.4	31.5
ER20-13/64"	13/64	20	21	17.4	31.5
ER20-7/32"	7/32	20	21	17.4	31.5
ER20-15/64"	15/64	20	21	17.4	31.5
ER20-1/4"	1/4	20	21	17.4	31.5
ER20-17/64"	17/64	20	21	17.4	31.5
ER20-9/32"	9/32	20	21	17.4	31.5
ER20-19/64"	19/64	20	21	17.4	31.5
ER20-5/16"	5/16	20	21	17.4	31.5
ER20-21/64"	21/64	20	21	17.4	31.5
ER20-11/32"	11/32	20	21	17.4	31.5
ER20-23/64"	23/64	20	21	17.4	31.5
ER20-3/8"	3/8	20	21	17.4	31.5
ER20-25/64"	25/64	20	21	17.4	31.5
ER20-13/32"	13/32	20	21	17.4	31.5
ER20-27/64"	27/64	20	21	17.4	31.5
ER20-7/16"	7/16	20	21	17.4	31.5
ER20-29/64"	29/64	20	21	17.4	31.5
ER20-15/32"	15/32	20	21	17.4	31.5
ER20-31/64"	31/64	20	21	17.4	31.5
ER20-1/2"	1/2	20	21	17.4	31.5
ER20-33/64"	33/64	20	21	17.4	31.5

## ER Collet

### ER 弹簧夹头

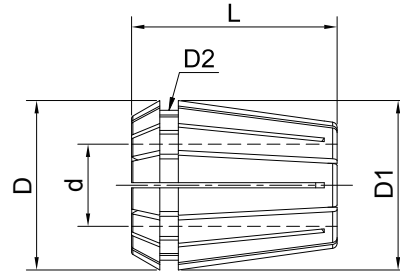

#### Metric

Size	d	D1	D	D2	L
ER25-3/64"	3/64	25	26	22	34
ER25-1/16"	1/16	25	26	22	34
ER25-5/64"	5/64	25	26	22	34
ER25-3/32"	3/32	25	26	22	34
ER25-7/64"	7/64	25	26	22	34
ER25-1/8"	1/8	25	26	22	34
ER25-9/64"	9/64	25	26	22	34
ER25-5/32"	5/32	25	26	22	34
ER25-11/64"	11/64	25	26	22	34
ER25-3/16"	3/16	25	26	22	34
ER25-13/64"	13/64	25	26	22	34
ER25-7/32"	7/32	25	26	22	34
ER25-15/64"	15/64	25	26	22	34
ER25-1/4"	1/4	25	26	22	34
ER25-17/64"	17/64	25	26	22	34
ER25-9/32"	9/32	25	26	22	34
ER25-19/64"	19/64	25	26	22	34
ER25-5/16"	5/16	25	26	22	34
ER25-21/64"	21/64	25	26	22	34
ER25-11/32"	11/32	25	26	22	34
ER25-23/64"	23/64	25	26	22	34
ER25-3/8"	3/8	25	26	22	34
ER25-25/64"	25/64	25	26	22	34
ER25-13/32"	13/32	25	26	22	34
ER25-27/64"	27/64	25	26	22	34
ER25-7/16"	7/16	25	26	22	34
ER25-29/64"	29/64	25	26	22	34
ER25-15/32"	15/32	25	26	22	34
ER25-31/64"	31/64	25	26	22	34
ER25-1/2"	1/2	25	26	22	34
ER25-33/64"	33/64	25	26	22	34
ER25-17/32"	17/32	25	26	22	34
ER25-35/64"	35/64	25	26	22	34
ER25-9/16"	9/16	25	26	22	34
ER25-37/64"	37/64	25	26	22	34

Size	d	D1	D	D2	L
ER25-19/32"	19/32	25	26	22	34
ER25-39/64"	39/64	25	26	22	34
ER25-5/8"	5/8	25	26	22	34

ER32-1/16"	1/16	32	33	29.2	40
ER32-3/32"	3/32	32	33	29.2	40
ER32-1/8"	1/8	32	33	29.2	40
ER32-5/32"	5/32	32	33	29.2	40
ER32-3/16"	3/16	32	33	29.2	40
ER32-7/32"	7/32	32	33	29.2	40
ER32-1/4"	1/4	32	33	29.2	40
ER32-9/32"	9/32	32	33	29.2	40
ER32-5/16"	5/16	32	33	29.2	40
ER32-11/32"	11/32	32	33	29.2	40
ER32-3/8"	3/8	32	33	29.2	40
ER32-13/32"	13/32	32	33	29.2	40
ER32-7/16"	7/16	32	33	29.2	40
ER32-15/32"	15/32	32	33	29.2	40
ER32-1/2"	1/2	32	33	29.2	40
ER32-17/32"	17/32	32	33	29.2	40
ER32-9/16"	9/16	32	33	29.2	40
ER32-19/32"	19/32	32	33	29.2	40
ER32-5/8"	5/8	32	33	29.2	40
ER32-21/32"	21/32	32	33	29.2	40
ER32-11/16"	11/16	32	33	29.2	40
ER32-23/32"	23/32	32	33	29.2	40
ER32-3/4"	3/4	32	33	29.2	40
ER32-25/32"	25/32	32	33	29.2	40

## ER Collet ER 弹簧夹头

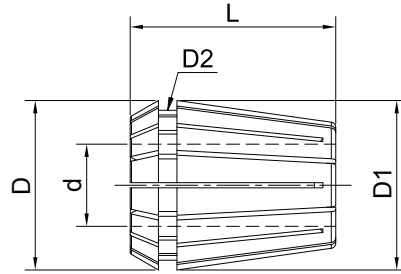

### Metric

Size	d	D1	D	D2	L
ER40-1/8"	1/8	40	41	36.2	46
ER40-5/32"	5/32	40	41	36.2	46
ER40-3/16"	3/16	40	41	36.2	46
ER40-7/32"	7/32	40	41	36.2	46
ER40-1/4"	1/4	40	41	36.2	46
ER40-9/32"	9/32	40	41	36.2	46
ER40-5/16"	5/16	40	41	36.2	46
ER40-11/32"	11/32	40	41	36.2	46
ER40-3/8"	3/8	40	41	36.2	46
ER40-13/32"	13/32	40	41	36.2	46
ER40-7/16"	7/16	40	41	36.2	46
ER40-15/32"	15/32	40	41	36.2	46
ER40-1/2"	1/2	40	41	36.2	46
ER40-17/32"	17/32	40	41	36.2	46
ER40-9/16"	9/16	40	41	36.2	46
ER40-19/32"	19/32	40	41	36.2	46
ER40-5/8"	5/8	40	41	36.2	46
ER40-21/32"	21/32	40	41	36.2	46
ER40-11/16"	11/16	40	41	36.2	46
ER40-23/32"	23/32	40	41	36.2	46
ER40-3/4"	3/4	40	41	36.2	46
ER40-25/32"	25/32	40	41	36.2	46
ER40-13/16"	13/16	40	41	36.2	46
ER40-27/32"	27/32	40	41	36.2	46
ER40-7/8"	7/8	40	41	36.2	46
ER40-29/32"	29/32	40	41	36.2	46
ER40-15/16"	15/16	40	41	36.2	46
ER40-31/32"	31/32	40	41	36.2	46

Size	d	D1	D	D2	L
ER50-1/4"	1/4	50	52	46	60
ER50-9/32"	9/32	50	52	46	60
ER50-5/16"	5/16	50	52	46	60
ER50-11/32"	11/32	50	52	46	60
ER50-3/8"	3/8	50	52	46	60
ER50-13/32"	13/32	50	52	46	60
ER50-7/16"	7/16	50	52	46	60
ER50-15/32"	15/32	50	52	46	60
ER50-1/2"	1/2	50	52	46	60
ER50-17/32"	17/32	50	52	46	60
ER50-9/16"	9/16	50	52	46	60
ER50-19/32"	19/32	50	52	46	60
ER50-5/8"	5/8	50	52	46	60
ER50-21/32"	21/32	50	52	46	60
ER50-11/16"	11/16	50	52	46	60
ER50-23/32"	23/32	50	52	46	60
ER50-3/4"	3/4	50	52	46	60
ER50-25/32"	25/32	50	52	46	60
ER50-13/16"	13/16	50	52	46	60
ER50-27/32"	27/32	50	52	46	60
ER50-7/8"	7/8	50	52	46	60
ER50-29/32"	29/32	50	52	46	60
ER50-15/16"	15/16	50	52	46	60
ER50-31/32"	31/32	50	52	46	60
ER50-1"	1"	50	52	46	60
ER50-1-1/32"	1-1/32	50	52	46	60
ER50-1-1/16"	1-1/16	50	52	46	60
ER50-1-3/32"	1-3/32	50	52	46	60
ER50-1-1/8"	1-1/8	50	52	46	60
ER50-1-5/32"	1-5/32	50	52	46	60
ER50-1-3/16"	1-3/16	50	52	46	60
ER50-1-7/32"	1-7/32	50	52	46	60
ER50-1-1/4"	1-1/4	50	52	46	60
ER50-1-9/32"	1-9/32	50	52	46	60
ER50-1-5/16"	1-5/16	50	52	46	60

## ER Collet Set

### ER 筒夹套装



#### Metric

Size	Collet Diameter	PCS/SET
ER8-9 PCS	1,1.5,2,2.5,3,3.5,4,4.5,5	9
ER8-5 PCS	1,2,3,4,5	5
ER11-7 PCS	1,2,3,4,5,6,7	7
ER11-13 PCS	1,1.5,2,2.5,3,3.5,4,4.5,5,5.5,6,6.5,7	13
ER16-10 PCS	1,2,3,4,5,6,7,8,9,10	10
ER20-13 PCS	1,2,3,4,5,6,7,8,9,10,11,12,13	13
ER25-15 PCS	2,3,4,5,6,7,8,9,10,11,12,13,14,15,16	15
ER32-18 PCS	3,4,5,6,7,8,9,10,11,12,13,14,15,16,17,18,19,20	18
ER40-23 PCS	4,5,6,7,8,9,10,11,12,13,14,15,16,17,18,19,20,21,22,23,24,25,26	23

#### Inch

Size	Collet Diameter	PCS/SET
ER8-6 PCS (inch)	1/32, 1/16, 3/32, 1/8, 5/32, 3/16	6
ER16-8 PCS (inch)	1/8, 5/32, 3/16, 7/32, 1/4, 5/16, 11/32, 3/8	8
ER20-11 PCS (inch)	1/8, 5/32, 3/16, 7/32, 1/4, 9/32, 5/16, 11/32, 3/8, 7/16, 1/2	11
ER25-9 PCS (inch)	1/8, 3/16, 1/4, 5/16, 3/8, 7/16, 1/2, 9/16, 5/8	9
ER32-18 PCS (inch)	1/8, 5/32, 3/16, 7/32, 1/4, 9/32, 5/16, 11/32, 3/8, 13/32, 7/16, 15/32, 1/2, 9/16, 5/8, 11/16, 23/32, 3/4"	18
ER40-23 PCS (inch)	1/8, 5/32, 3/16, 7/32, 1/4, 9/32, 5/16, 11/32, 3/8, 13/32, 7/16, 15/32, 1/2, 9/16, 5/8, 11/16, 23/32, 3/4, 13/16, 27/32, 7/8, 29/32, 1	23

## Rubber Sealed Collet ER 胶条止水筒夹

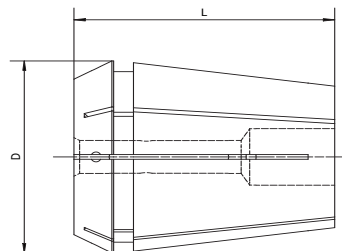

Size	D	L	Diameter
ERS16-03	16.74	27.5	3
ERS16-04	16.74	27.5	4
ERS16-05	16.74	27.5	5
ERS16-06	16.74	27.5	6
ERS16-07	16.74	27.5	7
ERS16-08	16.74	27.5	8
ERS16-09	16.74	27.5	9
ERS16-10	16.74	27.5	10

ERS20-03	20.74	31.5	3
ERS20-04	20.74	31.5	4
ERS20-05	20.74	31.5	5
ERS20-06	20.74	31.5	6
ERS20-07	20.74	31.5	7
ERS20-08	20.74	31.5	8
ERS20-09	20.74	31.5	9
ERS20-10	20.74	31.5	10
ERS20-11	20.74	31.5	11
ERS20-12	20.74	31.5	12
ERS20-13	20.74	31.5	13

Size	D	L	Diameter
ERS25-03	25.74	34	3
ERS25-04	25.74	34	4
ERS25-05	25.74	34	5
ERS25-06	25.74	34	6
ERS25-07	25.74	34	7
ERS25-08	25.74	34	8
ERS25-09	25.74	34	9
ERS25-10	25.74	34	10
ERS25-11	25.74	34	11
ERS25-12	25.74	34	12
ERS25-13	25.74	34	13
ERS25-14	25.74	34	14
ERS25-15	25.74	34	15
ERS25-16	25.74	34	16



## Rubber Sealed Collet

### ER 胶条止水筒夹

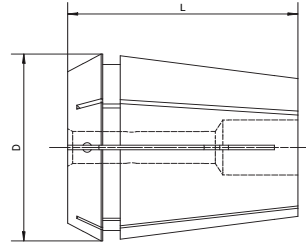

Size	D	L	Diameter
ERS32-03	32.74	40	3
ERS32-04	32.74	40	4
ERS32-05	32.74	40	5
ERS32-06	32.74	40	6
ERS32-07	32.74	40	7
ERS32-08	32.74	40	8
ERS32-09	32.74	40	9
ERS32-10	32.74	40	10
ERS32-11	32.74	40	11
ERS32-12	32.74	40	12
ERS32-13	32.74	40	13
ERS32-14	32.74	40	14
ERS32-15	32.74	40	15
ERS32-16	32.74	40	16
ERS32-17	32.74	40	17
ERS32-18	32.74	40	18
ERS32-19	32.74	40	19
ERS32-20	32.74	40	20

Size	D	L	Diameter
ERS40-04	40.74	46	4
ERS40-05	40.74	46	5
ERS40-06	40.74	46	6
ERS40-07	40.74	46	7
ERS40-08	40.74	46	8
ERS40-09	40.74	46	9
ERS40-10	40.74	46	10
ERS40-11	40.74	46	11
ERS40-12	40.74	46	12
ERS40-13	40.74	46	13
ERS40-14	40.74	46	14
ERS40-15	40.74	46	15
ERS40-16	40.74	46	16
ERS40-17	40.74	46	17
ERS40-18	40.74	46	18
ERS40-19	40.74	46	19
ERS40-20	40.74	46	20
ERS40-21	40.74	46	21
ERS40-22	40.74	46	22
ERS40-23	40.74	46	23
ERS40-24	40.74	46	24
ERS40-25	40.74	46	25
ERS40-26	40.74	46	26



## ER Sealed Collet ER 刚性止水筒夹

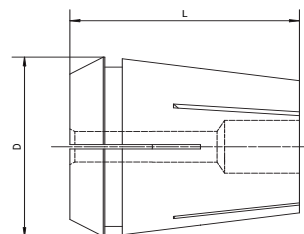

Size	D	L	Diameter
ER11SS-03	11.3	18	3
ER11SS-03.5	11.3	18	3.5
ER11SS-04	11.3	18	4
ER11SS-04.5	11.3	18	4.5
ER11SS-05	11.3	18	5
ER11SS-05.5	11.3	18	5.5
ER11SS-06	11.3	18	6
ER11SS-06.5	11.3	18	6.5
ER11SS-07	11.3	18	7

ER16SS-03	16.74	27.5	3
ER16SS-04	16.74	27.5	4
ER16SS-05	16.74	27.5	5
ER16SS-06	16.74	27.5	6
ER16SS-07	16.74	27.5	7
ER16SS-08	16.74	27.5	8
ER16SS-09	16.74	27.5	9
ER16SS-10	16.74	27.5	10

ER20SS-03	20.74	31.5	3
ER20SS-04	20.74	31.5	4
ER20SS-05	20.74	31.5	5
ER20SS-06	20.74	31.5	6
ER20SS-07	20.74	31.5	7
ER20SS-08	20.74	31.5	8
ER20SS-09	20.74	31.5	9
ER20SS-10	20.74	31.5	10
ER20SS-11	20.74	31.5	11
ER20SS-12	20.74	31.5	12
ER20SS-13	20.74	31.5	13

Size	D	L	Diameter
ER25SS-03	25.74	34	3
ER25SS-04	25.74	34	4
ER25SS-05	25.74	34	5
ER25SS-06	25.74	34	6
ER25SS-07	25.74	34	7
ER25SS-08	25.74	34	8
ER25SS-09	25.74	34	9
ER25SS-10	25.74	34	10
ER25SS-11	25.74	34	11
ER25SS-12	25.74	34	12
ER25SS-13	25.74	34	13
ER25SS-14	25.74	34	14
ER25SS-15	25.74	34	15
ER25SS-16	25.74	34	16

## ER Sealed Collet

### ER 刚性止水筒夹

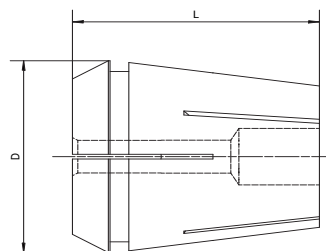

Size	D	L	Diameter
ER32SS-03	32.74	40	3
ER32SS-04	32.74	40	4
ER32SS-05	32.74	40	5
ER32SS-06	32.74	40	6
ER32SS-07	32.74	40	7
ER32SS-08	32.74	40	8
ER32SS-09	32.74	40	9
ER32SS-10	32.74	40	10
ER32SS-11	32.74	40	11
ER32SS-12	32.74	40	12
ER32SS-13	32.74	40	13
ER32SS-14	32.74	40	14
ER32SS-15	32.74	40	15
ER32SS-16	32.74	40	16
ER32SS-17	32.74	40	17
ER32SS-18	32.74	40	18
ER32SS-19	32.74	40	19
ER32SS-20	32.74	40	20

Size	D	L	Diameter
ER40SS-04	40.74	46	4
ER40SS-05	40.74	46	5
ER40SS-06	40.74	46	6
ER40SS-07	40.74	46	7
ER40SS-08	40.74	46	8
ER40SS-09	40.74	46	9
ER40SS-10	40.74	46	10
ER40SS-11	40.74	46	11
ER40SS-12	40.74	46	12
ER40SS-13	40.74	46	13
ER40SS-14	40.74	46	14
ER40SS-15	40.74	46	15
ER40SS-16	40.74	46	16
ER40SS-17	40.74	46	17
ER40SS-18	40.74	46	18
ER40SS-19	40.74	46	19
ER40SS-20	40.74	46	20
ER40SS-21	40.74	46	21
ER40SS-22	40.74	46	22
ER40SS-23	40.74	46	23
ER40SS-24	40.74	46	24
ER40SS-25	40.74	46	25
ER40SS-26	40.74	46	26

## ER Tapping Collet ER 攻丝筒夹

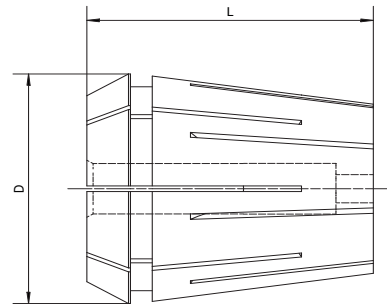

Size	D	L	Diameter
ER16G (3.5*2.7)	16.74	27.5	3.5*2.7
ER16G (4.0*3.0)	16.74	27.5	4.0*3.0
ER16G (4.5*3.4)	16.74	27.5	4.5*3.4
ER16G (5.5*4.3)	16.74	27.5	5.5*4.3
ER16G (6*4.9)	16.74	27.5	6*4.9
ER16G (7*5.5)	16.74	27.5	7*5.5
ER16G (8*6.2)	16.74	27.5	8*6.2

ER20G (3.5*2.7)	20.74	31.5	3.5*2.7
ER20G (4.0*3.0)	20.74	31.5	4.0*3.0
ER20G (4.5*3.4)	20.74	31.5	4.5*3.4
ER20G (5.5*4.3)	20.74	31.5	5.5*4.3
ER20G (6.0*4.9)	20.74	31.5	6.0*4.9
ER20G (7*5.5)	20.74	31.5	7*5.5
ER20G (8*6.2)	20.74	31.5	8*6.2
ER20G (9*7.0)	20.74	31.5	9*7.0
ER20G (10*8.0)	20.74	31.5	10*8.0

ER25G (3.5*2.7)	25.74	34	3.5*2.7
ER25G (4.0*3.0)	25.74	34	4.0*3.0
ER25G (4.5*3.4)	25.74	34	4.5*3.4
ER25G (5.5*4.3)	25.74	34	5.5*4.3
ER25G (6.0*4.9)	25.74	34	6.0*4.9
ER25G (7.0*5.5)	25.74	34	7.0*5.5
ER25G (8.0*6.2)	25.74	34	8.0*6.2
ER25G (9*7.0)	25.74	34	9*7.0
ER25G (10*8.0)	25.74	34	10*8.0
ER25G (11*9.0)	25.74	34	11*9.0
ER25G (12*9.0)	25.74	34	12*9.0
ER25G (14*11.0)	25.74	34	14*11.0
ER25G (16*12.0)	25.74	34	16*12.0

Size	D	L	Diameter
ER32G (3.5*2.7)	32.74	40	3.5*2.7
ER32G (4.0*3.0)	32.74	40	4.0*3.0
ER32G (4.5*3.4)	32.74	40	4.5*3.4
ER32G (5.5*4.3)	32.74	40	5.5*4.3
ER32G (6.0*4.9)	32.74	40	6.0*4.9
ER32G (7.0*5.5)	32.74	40	7.0*5.5
ER32G (8.0*6.2)	32.74	40	8.0*6.2
ER32G (9.0*7.0)	32.74	40	9.0*7.0
ER32G (10*8.0)	32.74	40	10*8.0
ER32G (11*9.0)	32.74	40	11*9.0
ER32G (12*9.0)	32.74	40	12*9.0
ER32G (14*11.0)	32.74	40	14*11.0
ER32G (16*12.0)	32.74	40	16*12.0
ER32G (18*14.5)	32.74	40	18*14.5
ER32G (20*16.0)	32.74	40	20*16.0

ER40G (3.5*2.7)	40.74	46	3.5*2.7
ER40G (4.0*3.0)	40.74	46	4.0*3.0
ER40G (4.5*3.4)	40.74	46	4.5*3.4
ER40G (5.5*4.3)	40.74	46	5.5*4.3
ER40G (6.0*4.9)	40.74	46	6.0*4.9
ER40G (7.0*5.5)	40.74	46	7.0*5.5
ER40G (8.0*6.2)	40.74	46	8.0*6.2
ER40G (9.0*7.0)	40.74	46	9.0*7.0
ER40G (10.0*8.0)	40.74	46	10.0*8.0
ER40G (11*9.0)	40.74	46	11*9.0
ER40G (12*9.0)	40.74	46	12*9.0
ER40G (14*11.0)	40.74	46	14*11.0
ER40G (16*12.0)	40.74	46	16*12.0
ER40G (18*14.5)	40.74	46	18*14.5
ER40G (20*16.0)	40.74	46	20*16.0
ER40G (22*18.0)	40.74	46	22*18.0
ER40G (25*20.0)	40.74	46	25*20.0

## ER Tapping Sealed Collet

### ER 止水攻丝筒夹

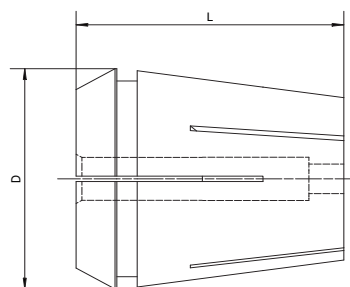

Size	D	L	Diameter
ERS16G (3.5*2.7)	16.74	27.5	3.5*2.7
ERS16G (4.0*3.0)	16.74	27.5	4.0*3.0
ERS16G (4.5*3.4)	16.74	27.5	4.5*3.4
ERS16G (5.5*4.3)	16.74	27.5	5.5*4.3
ERS16G (6*4.9)	16.74	27.5	6*4.9
ERS16G (7*5.5)	16.74	27.5	7*5.5
ERS16G (8*6.2)	16.74	27.5	8*6.2

ERS20G (3.5*2.7)	20.74	31.5	3.5*2.7
ERS20G (4.0*3.0)	20.74	31.5	4.0*3.0
ERS20G (4.5*3.4)	20.74	31.5	4.5*3.4
ERS20G (5.5*4.3)	20.74	31.5	5.5*4.3
ERS20G (6.0*4.9)	20.74	31.5	6.0*4.9
ERS20G (7*5.5)	20.74	31.5	7*5.5
ERS20G (8*6.2)	20.74	31.5	8*6.2
ERS20G (9*7.0)	20.74	31.5	9*7.0
ERS20G (10*8.0)	20.74	31.5	10*8.0

ERS25G (3.5*2.7)	25.74	34	3.5*2.7
ERS25G (4.0*3.0)	25.74	34	4.0*3.0
ERS25G (4.5*3.4)	25.74	34	4.5*3.4
ERS25G (5.5*4.3)	25.74	34	5.5*4.3
ERS25G (6.0*4.9)	25.74	34	6.0*4.9
ERS25G (7.0*5.5)	25.74	34	7.0*5.5
ERS25G (8.0*6.2)	25.74	34	8.0*6.2
ERS25G (9*7.0)	25.74	34	9*7.0
ERS25G (10*8.0)	25.74	34	10*8.0
ERS25G (11*9.0)	25.74	34	11*9.0
ERS25G (12*9.0)	25.74	34	12*9.0
ERS25G (14*11.0)	25.74	34	14*11.0
ERS25G (16*12.0)	25.74	34	16*12.0

Size	D	L	Diameter
ERS32G (3.5*2.7)	32.74	40	3.5*2.7
ERS32G (4.0*3.0)	32.74	40	4.0*3.0
ERS32G (4.5*3.4)	32.74	40	4.5*3.4
ERS32G (5.5*4.3)	32.74	40	5.5*4.3
ERS32G (6.0*4.9)	32.74	40	6.0*4.9
ERS32G (7.0*5.5)	32.74	40	7.0*5.5
ERS32G (8.0*6.2)	32.74	40	8.0*6.2
ERS32G (9.0*7.0)	32.74	40	9.0*7.0
ERS32G (10*8.0)	32.74	40	10*8.0
ERS32G (11*9.0)	32.74	40	11*9.0
ERS32G (12*9.0)	32.74	40	12*9.0
ERS32G (14*11.0)	32.74	40	14*11.0
ERS32G (16*12.0)	32.74	40	16*12.0
ERS32G (18*14.5)	32.74	40	18*14.5
ERS32G (20*16.0)	32.74	40	20*16.0

ERS40G (3.5*2.7)	40.74	46	3.5*2.7
ERS40G (4.0*3.0)	40.74	46	4.0*3.0
ERS40G (4.5*3.4)	40.74	46	4.5*3.4
ERS40G (5.5*4.3)	40.74	46	5.5*4.3
ERS40G (6.0*4.9)	40.74	46	6.0*4.9
ERS40G (7.0*5.5)	40.74	46	7.0*5.5
ERS40G (8.0*6.2)	40.74	46	8.0*6.2
ERS40G (9.0*7.0)	40.74	46	9.0*7.0
ERS40G (10.0*8.0)	40.74	46	10.0*8.0
ERS40G (11*9.0)	40.74	46	11*9.0
ERS40G (12*9.0)	40.74	46	12*9.0
ERS40G (14*11.0)	40.74	46	14*11.0
ERS40G (16*12.0)	40.74	46	16*12.0
ERS40G (18*14.5)	40.74	46	18*14.5
ERS40G (20*16.0)	40.74	46	20*16.0
ERS40G (22*18.0)	40.74	46	22*18.0
ERS40G (25*20.0)	40.74	46	25*20.0

## Straight Shank Collet SC 直柄筒夹

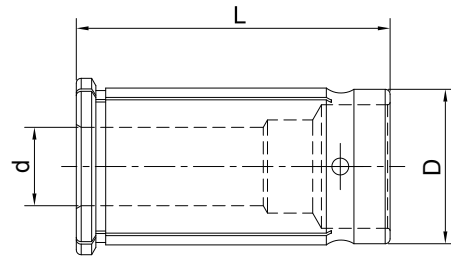

### Metric

Size	d	D	L
SC16-03	3	16	45
SC16-04	4	16	45
SC16-05	5	16	45
SC16-06	6	16	45
SC16-08	8	16	45
SC16-10	10	16	45
SC16-12	12	16	45

SC20-03	3	20	50
SC20-04	4	20	50
SC20-05	5	20	50
SC20-06	6	20	50
SC20-08	8	20	50
SC20-10	10	20	50
SC20-12	12	20	50
SC20-14	14	20	50
SC20-16	16	20	50

SC25-03	3	25	60
SC25-04	4	25	60
SC25-05	5	25	60
SC25-06	6	25	60
SC25-08	8	25	60
SC25-10	10	25	60
SC25-12	12	25	60
SC25-14	14	25	60
SC25-16	16	25	60
SC25-18	18	25	60
SC25-20	20	25	60

Size	d	D	L
SC32-03	3	32	64
SC32-04	4	32	64
SC32-05	5	32	64
SC32-06	6	32	64
SC32-08	8	32	64
SC32-10	10	32	64
SC32-12	12	32	64
SC32-14	14	32	64
SC32-16	16	32	64
SC32-18	18	32	64
SC32-20	20	32	64
SC32-25	25	32	64
SC42-03	3	42	80
SC42-04	4	42	80
SC42-05	5	42	80
SC42-06	6	42	80
SC42-08	8	42	80
SC42-10	10	42	80
SC42-12	12	42	80
SC42-14	14	42	80
SC42-16	16	42	80
SC42-18	18	42	80
SC42-20	20	42	80
SC42-22	22	42	80
SC42-24	24	42	80
SC42-25	25	42	80
SC42-28	28	42	80
SC42-30	30	42	80
SC42-32	32	42	80

## OZ Collet OZ 筒夹 B 型

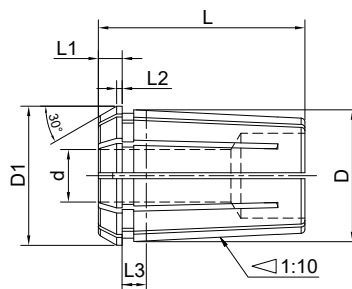

Size	d	D	D1	L	L1	L2	L3
OZ25B-02	2	32.9	35.05	52	6	1.4	10
OZ25B-03	3	32.9	35.05	52	6	1.4	10
OZ25B-04	4	32.9	35.05	52	6	1.4	10
OZ25B-05	5	32.9	35.05	52	6	1.4	10
OZ25B-06	6	32.9	35.05	52	6	1.4	10
OZ25B-07	7	32.9	35.05	52	6	1.4	10
OZ25B-08	8	32.9	35.05	52	6	1.4	10
OZ25B-09	9	32.9	35.05	52	6	1.4	10
OZ25B-10	10	32.9	35.05	52	6	1.4	10
OZ25B-11	11	32.9	35.05	52	6	1.4	10
OZ25B-12	12	32.9	35.05	52	6	1.4	10
OZ25B-13	13	32.9	35.05	52	6	1.4	10
OZ25B-14	14	32.9	35.05	52	6	1.4	10
OZ25B-15	15	32.9	35.05	52	6	1.4	10
OZ25B-16	16	32.9	35.05	52	6	1.4	10
OZ25B-17	17	32.9	35.05	52	6	1.4	10
OZ25B-18	18	32.9	35.05	52	6	1.4	10
OZ25B-19	19	32.9	35.05	52	6	1.4	10
OZ25B-20	20	32.9	35.05	52	6	1.4	10
OZ25B-21	21	32.9	35.05	52	6	1.4	10
OZ25B-22	22	32.9	35.05	52	6	1.4	10
OZ25B-23	23	32.9	35.05	52	6	1.4	10
OZ25B-24	24	32.9	35.05	52	6	1.4	10
OZ25B-25	25	32.9	35.05	52	6	1.4	10

**OZ Collet**  
**OZ 筒夹 B 型**

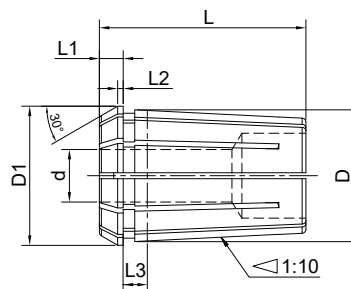

Size	d	D	D1	L	L1	L2	L3
OZ32B-04	4	41.3	43.7	60	6	1.45	11
OZ32B-05	5	41.3	43.7	60	6	1.45	11
OZ32B-06	6	41.3	43.7	60	6	1.45	11
OZ32B-07	7	41.3	43.7	60	6	1.45	11
OZ32B-08	8	41.3	43.7	60	6	1.45	11
OZ32B-09	9	41.3	43.7	60	6	1.45	11
OZ32B-10	10	41.3	43.7	60	6	1.45	11
OZ32B-11	11	41.3	43.7	60	6	1.45	11
OZ32B-12	12	41.3	43.7	60	6	1.45	11
OZ32B-13	13	41.3	43.7	60	6	1.45	11
OZ32B-14	14	41.3	43.7	60	6	1.45	11
OZ32B-15	15	41.3	43.7	60	6	1.45	11
OZ32B-16	16	41.3	43.7	60	6	1.45	11
OZ32B-17	17	41.3	43.7	60	6	1.45	11
OZ32B-18	18	41.3	43.7	60	6	1.45	11
OZ32B-19	19	41.3	43.7	60	6	1.45	11
OZ32B-20	20	41.3	43.7	60	6	1.45	11
OZ32B-21	21	41.3	43.7	60	6	1.45	11
OZ32B-22	22	41.3	43.7	60	6	1.45	11
OZ32B-23	23	41.3	43.7	60	6	1.45	11
OZ32B-24	24	41.3	43.7	60	6	1.45	11
OZ32B-25	25	41.3	43.7	60	6	1.45	11
OZ32B-26	26	41.3	43.7	60	6	1.45	11
OZ32B-27	27	41.3	43.7	60	6	1.45	11
OZ32B-28	28	41.3	43.7	60	6	1.45	11
OZ32B-29	29	41.3	43.7	60	6	1.45	11
OZ32B-30	30	41.3	43.7	60	6	1.45	11
OZ32B-31	31	41.3	43.7	60	6	1.45	11
OZ32B-32	32	41.3	43.7	60	6	1.45	11

## SKS Collet

### SKS 高速筒夹

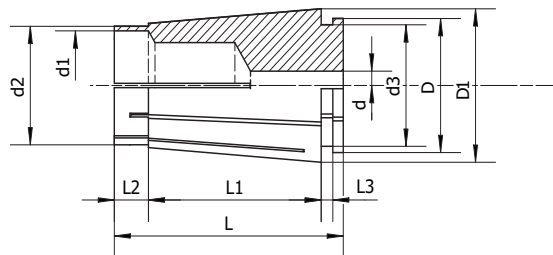

Size	d	D	D1	d1	d2	d3	L	L1	L2	L3
SKS06-02	1.75-2.0	8.6	10.5	6	7.5	7.8	25	17.5	3.5	2.5
SKS06-03	2.8-3.0	8.6	10.5	6	7.5	7.8	25	17.5	3.5	2.5
SKS06-04	3.5-4.0	8.6	10.5	6	7.5	7.8	25	17.5	3.5	2.5
SKS06-05	4.5-5.0	8.6	10.5	6	7.5	7.8	25	17.5	3.5	2.5
SKS06-06	5.5-6.0	8.6	10.5	6	7.5	7.8	25	17.5	3.5	2.5
SKS10-02	1.75-2.0	13.1	15.5	10	12	12	30.5	22	5	2.3
SKS10-03	2.75-3.0	13.1	15.5	10	12	12	30.5	22	5	2.3
SKS10-04	3.5-4.0	13.1	15.5	10	12	12	30.5	22	5	2.3
SKS10-05	4.5-5.0	13.1	15.5	10	12	12	30.5	22	5	2.3
SKS10-06	5.5-6.0	13.1	15.5	10	12	12	30.5	22	5	2.3
SKS10-07	6.5-7.0	13.1	15.5	10	12	12	30.5	22	5	2.3
SKS10-08	7.5-8.0	13.1	15.5	10	12	12	30.5	22	5	2.3
SKS10-09	8.5-9.0	13.1	15.5	10	12	12	30.5	22	5	2.3
SKS10-10	9.5-10.0	13.1	15.5	10	12	12	30.5	22	5	2.3
SKS16-03	2.75-3.0	20.5	24.45	18.6	15.3	18.8	45.5	32	8	2.8
SKS16-04	3.5-4.0	20.5	24.45	18.6	15.3	18.8	45.5	32	8	2.8
SKS16-05	4.5-5.0	20.5	24.45	18.6	15.3	18.8	45.5	32	8	2.8
SKS16-06	5.5-6.0	20.5	24.45	18.6	15.3	18.8	45.5	32	8	2.8
SKS16-07	6.5-7.0	20.5	24.45	18.6	15.3	18.8	45.5	32	8	2.8
SKS16-08	7.5-8.0	20.5	24.45	18.6	15.3	18.8	45.5	32	8	2.8
SKS16-09	8.5-9.0	20.5	24.45	18.6	15.3	18.8	45.5	32	8	2.8
SKS16-10	9.5-10.0	20.5	24.45	18.6	15.3	18.8	45.5	32	8	2.8
SKS16-11	10.5-11.0	20.5	24.45	18.6	15.3	18.8	45.5	32	8	2.8
SKS16-12	11.5-12.0	20.5	24.45	18.6	15.3	18.8	45.5	32	8	2.8
SKS16-13	12.5-13.0	20.5	24.45	18.6	15.3	18.8	45.5	32	8	2.8
SKS16-14	13.5-14.0	20.5	24.45	18.6	15.3	18.8	45.5	32	8	2.8
SKS16-15	14.5-15.0	20.5	24.45	18.6	15.3	18.8	45.5	32	8	2.8
SKS16-16	15.5-16.0	20.5	24.45	18.6	15.3	18.8	45.5	32	8	2.8



**SKS Collet**  
**SKS 高速筒夹**

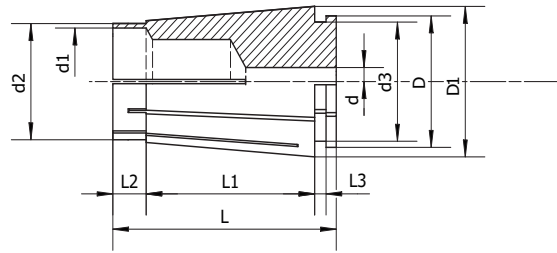
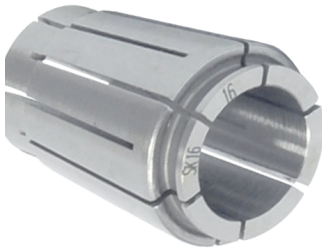

Size	d	D	D1	d1	d2	d3	L	L1	L2	L3
SKS25-03	2.5-3.0	29.9	35.6	25.4	28.8	28.2	57	43	8.5	2.9
SKS25-04	3.5-4.0	29.9	35.6	25.4	28.8	28.2	57	43	8.5	2.9
SKS25-05	4.5-5.0	29.9	35.6	25.4	28.8	28.2	57	43	8.5	2.9
SKS25-06	5.5-6.0	29.9	35.6	25.4	28.8	28.2	57	43	8.5	2.9
SKS25-08	7.5-8.0	29.9	35.6	25.4	28.8	28.2	57	43	8.5	2.9
SKS25-10	9.5-10.0	29.9	35.6	25.4	28.8	28.2	57	43	8.5	2.9
SKS25-12	11.5-12.0	29.9	35.6	25.4	28.8	28.2	57	43	8.5	2.9
SKS25-14	13.5-14.0	29.9	35.6	25.4	28.8	28.2	57	43	8.5	2.9
SKS25-16	15.5-16.0	29.9	35.6	25.4	28.8	28.2	57	43	8.5	2.9
SKS25-18	17.5-18.0	29.9	35.6	25.4	28.8	28.2	57	43	8.5	2.9
SKS25-20	19.5-20.0	29.9	35.6	25.4	28.8	28.2	57	43	8.5	2.9
SKS25-22	21.5-22.0	29.9	35.6	25.4	28.8	28.2	57	43	8.5	2.9
SKS25-24	23.5-24.0	29.9	35.6	25.4	28.8	28.2	57	43	8.5	2.9
SKS25-25	24.5-25.0	29.9	35.6	25.4	28.8	28.2	57	43	8.5	2.9

## DC Collet

### DC 后拉筒夹

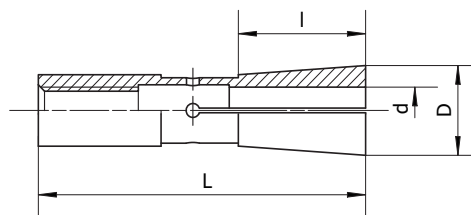

Size	d	D	L	l	M
DC04-02	2	7	31	10	M5*0.8P
DC04-03	3	7	31	14	M5*0.8P
DC04-04	4	7	31	14	M5*0.8P
DC06-03	3	9.6	14	14	M5*0.8P
DC06-04	4	9.6	36	14	M5*0.8P
DC06-05	5	9.6	36	16	M5*0.8P
DC06-06	6	9.6	36	16	M5*0.8P
DC08-03	3	15	45	15	M5*0.8P
DC08-04	4	15	45	16	M5*0.8P
DC08-06	6	15	45	24	M5*0.8P
DC08-08	8	15	45	26	M5*0.8P
DC10-03	3	19	52	15	M5*0.8P
DC10-04	4	19	52	18	M5*0.8P
DC10-06	6	19	52	24	M8*1.25P
DC10-08	8	19	52	26	M8*1.25P
DC10-10	10	19	52	30	M8*1.25P
DC12-04	4	22	60	15	M8*1.25P
DC12-06	6	22	60	25	M8*1.25P
DC12-08	8	22	60	30	M8*1.25P
DC12-10	10	22	60	33	M8*1.25P
DC12-12	12	22	60	33	M8*1.25P

## Tapping Collet with Clutch 过载保护攻丝筒夹 (公制)

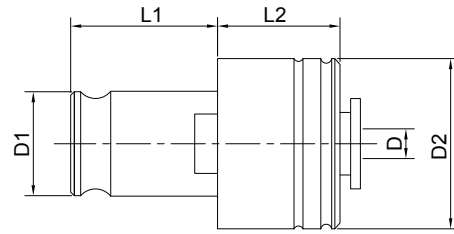

Size	Collet	M	D	□	D1	D2	L1	L2
FES1 M2(2.80x2.1)	FES 1	M2	2.8	2.1	19	33	21.5	25
FES1 M3(3.5*2.7)	FES 1	M3	3.5	2.7	19	33	21.5	25
FES1 M3.5(4*3)	FES 1	M3.5	4	3	19	33	21.5	25
FES1 M4(5*4)	FES 1	M4	5	4	19	33	21.5	25
FES1 M4(4.5*3.4)	FES 1	M4	4.5	3.4	19	33	21.5	25
FES1 M5(6*4.9)	FES 1	M5	6	4.9	19	33	21.5	25
FES1 M6(6.3*5)	FES 1	M6	6.3	5	19	33	21.5	25
FES1 M6(6*4.9)	FES 1	M6	6	4.9	19	33	21.5	25
FES1 M8(8*6.3)	FES 1	M8	8	6.3	19	33	21.5	25
FES1 M10(10*8)	FES 1	M10	10	8	19	33	21.5	25
FES1 M10(7*5.5)	FES 1	M10	7	5.5	19	33	21.5	25
FES1 M12(9*7.1)	FES 1	M12	9	7.1	19	33	21.5	25
FES1 M12(9*7)	FES 1	M12	9	7	19	33	21.5	25
FES1 M14(11*9)	FES 1	M14	11	9	19	33	21.5	25

## Tapping Collet with Clutch 过载保护攻丝筒夹 (公制)

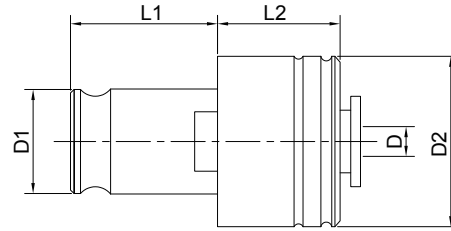

Size	Collet	M	D	□	D1	D2	L1	L2
FES2 M5(6*4.9)	FES 2	M5	6	4.9	31	51	35	35
FES2 M6(6.3*5)	FES 2	M6	6.3	5	31	51	35	35
FES2 M6(6*4.9)	FES 2	M6	6	4.9	31	51	35	35
FES2 M8(8*6.3)	FES 2	M8	8	6.3	31	51	35	35
FES2 M10(10*8)	FES 2	M10	10	8	31	51	35	35
FES2 M10(7*5.5)	FES 2	M10	7	5.5	31	51	35	35
FES2 M12(9*7.1)	FES 2	M12	9	7.1	31	51	35	35
FES2 M12(9*7)	FES 2	M12	9	7	31	51	35	35
FES2 M14(11*9)	FES 2	M14	11	9	31	51	35	35
FES2 M16(12.5*10)	FES 2	M16	12.5	10	31	51	35	35
FES2 M16(12*9)	FES 2	M16	12	9	31	51	35	35
FES2 M18(14*11)	FES 2	M18	14	11	31	51	35	35
FES2 M20(16*12)	FES 2	M20	16	12	31	51	35	35
FES2 M22(18*14.5)	FES 2	M22	18	14.5	31	51	35	35
FES2 M24(18*14.5)	FES 2	M24	18	14.5	31	51	35	35
FES2 M24(16*12.5)	FES 2	M24	16	12.5	31	51	35	35
FES3 M14(11*9)	FES 3	M14	11	9	48	73	55.5	45
FES3 M16(12*9)	FES 3	M16	12	9	48	73	55.5	45
FES3 M18(14*11)	FES 3	M18	14	11	48	73	55.5	45
FES3 M20(16*12)	FES 3	M20	16	12	48	73	55.5	45
FES3 M22(18*14.5)	FES 3	M22	18	14.5	48	73	55.5	45
FES3 M24(18*14.5)	FES 3	M24	18	14.5	48	73	55.5	45
FES3 M27(20*16)	FES 3	M27	20	16	48	73	55.5	45
FES3 M30(22*18)	FES 3	M30	22	18	48	73	55.5	45
FES3 M33(25*20)	FES 3	M33	25	20	48	73	55.5	45
FES3 M36(28*22)	FES 3	M36	28	22	48	73	55.5	45

## Tapping Collet with Clutch 过载保护攻丝筒夹 (英制)

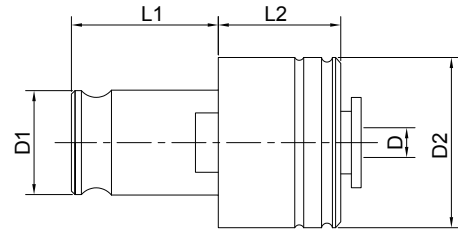

Size	Collet	ANSI	Metric	D	□	D1	D2	L1	L2
0-6" M1.6-M3.5	FES 1	0-6"	M1.6-M3.5	0.141	0.11	19	33	21.5	25
8, 5/32 M4	FES 1	8, 5/32	M4	0.168	0.131	19	33	21.5	25
10, 3/16" M4.5 M5	FES 1	10, 3/16"	M4.5 M5	0.194	0.152	19	33	21.5	25
12, 7/32"	FES 1	12, 7/32"		0.22	0.165	19	33	21.5	25
1/4" M6 M6.3	FES 1	1/4"	M6 M6.3	0.255	0.191	19	33	21.5	25
5/16" M7 M8	FES 1	5/16"	M7 M8	0.318	0.238	19	33	21.5	25
3/8" M10	FES 1	3/8"	M10	0.381	0.286	19	33	21.5	25
7/16" M11	FES 1	7/16"	M11	0.323	0.242	19	33	21.5	25
1/2" M12 M12.5	FES 1	1/2"	M12 M12.5	0.367	0.275	19	33	21.5	25
9/16" M14	FES 1	9/16"	M14	0.429	0.322	19	33	21.5	25
1/8" NPT	FES 1	1/8" NPT		0.437	0.328	19	33	21.5	25
5/16" M7 M8	FES 2	5/16"	M7 M8	0.318	0.238	31	51	35	35
3/8" M10	FES 2	3/8"	M10	0.381	0.286	31	51	35	35
7/16" M11	FES 2	7/16"	M11	0.323	0.242	31	51	35	35
1/2" M12 M12.5	FES 2	1/2"	M12 M12.5	0.367	0.275	31	51	35	35
9/16" M14	FES 2	9/16"	M14	0.429	0.322	31	51	35	35
5/8" M16	FES 2	5/8"	M16	0.48	0.36	31	51	35	35
11/16" M18	FES 2	11/16"	M18	0.542	0.406	31	51	35	35
3/4"	FES 2	3/4"		0.59	0.442	31	51	35	35
13/16" M20	FES 2	13/16"	M20	0.652	0.489	31	51	35	35
7/8" M22	FES 2	7/8"	M22	0.697	0.523	31	51	35	35
1/4" NPT	FES 2	1/4" NPT		0.562	0.421	31	51	35	35
3/8" NPT	FES 2	3/8" NPT		0.7	0.531	31	51	35	35
1/2" NPT	FES 2	1/2" NPT		0.687	0.515	31	51	35	35
13/16" M20	FES 3	13/16"	M20	0.652	0.489	48	73	55.5	45
7/8" M22	FES 3	7/8"	M22	0.697	0.523	48	73	55.5	45
15/16" M24	FES 3	15/16"	M24	0.76	0.57	48	73	55.5	45
1" M25	FES 3	1"	M25	0.8	0.6	48	73	55.5	45
1-1/8", 1-1/16" M27	FES 3	1-1/8", 1-1/16"	M27	0.896	0.672	48	73	55.5	45
1-1/4", 1-3/16 M30	FES 3	1-1/4", 1-3/16	M30	1.021	0.766	48	73	55.5	45
1-3/8", 1-5/16 M33	FES 3	1-3/8", 1-5/16	M33	1.108	0.831	48	73	55.5	45
1/2" NPT	FES 3	1/2" NPT		0.687	0.515	48	73	55.5	45
3/4" NPT	FES 3	3/4" NPT		0.906	0.678	48	73	55.5	45
1" NPT	FES 3	1" NPT		1.125	0.843	48	73	55.5	45

## Tapping Collet without Clutch

### 无过载保护攻丝筒夹（公制）

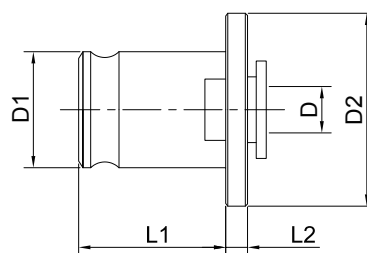

Size	Collet	M	D	□	D1	D2	L1	L2
FE1 M2(2.8*2.1)	FE 1	M2	2.8	2.1	19	30	21.5	7
FE1 M3(3.5*2.7)	FE 1	M3	3.5	2.7	19	30	21.5	7
FE1 M4(5*4)	FE 1	M4	5	4	19	30	21.5	7
FE1 M4(4.5*3.4)	FE 1	M4	4.5	3.4	19	30	21.5	7
FE1 M6(6*4.9)	FE 1	M6	6	4.9	19	30	21.5	7
FE1 M8(8*6.2)	FE 1	M8	8	6.2	19	30	21.5	7
FE1 M10(10*8)	FE 1	M10	10	8	19	30	21.5	7
FE1 M10(7*5.5)	FE 1	M10	7	5.5	19	30	21.5	7
FE1 M12(9*7)	FE 1	M12	9	7	19	30	21.5	7
FE2 M8(6*4.9)	FE 2	M8	6	4.9	31	48	35	11
FE2 M8(8*6.2)	FE 2	M8	8	6.2	31	48	35	11
FE2 M10(10*8)	FE 2	M10	10	8	31	48	35	11
FE2 M10(7*5.5)	FE 2	M10	7	5.5	31	48	35	11
FE2 M12(9*7.1)	FE 2	M12	9	7.1	31	48	35	11
FE2 M14(11*9)	FE 2	M14	11	9	31	48	35	11
FE2 M16(12*9)	FE 2	M16	12	9	31	48	35	11
FE2 M18(14*11)	FE 2	M18	14	11	31	48	35	11
FE2 M20(16*12)	FE 2	M20	16	12	31	48	35	11
FE3 M14(11*9)	FE 3	M14	11	9	48	70	55.5	13.5
FE3 M16(12*9)	FE 3	M16	12	9	48	70	55.5	13.5
FE3 M18(14*11)	FE 3	M18	14	11	48	70	55.5	13.5
FE3 M20(16*12)	FE 3	M20	16	12	48	70	55.5	13.5
FE3 M24(18*14.5)	FE 3	M24	18	14.5	48	70	55.5	13.5
FE3 M27(20*16)	FE 3	M27	20	16	48	70	55.5	13.5
FE3 M30(22*18)	FE 3	M30	22	18	48	70	55.5	13.5
FE3 M33(25*20)	FE 3	M33	25	20	48	70	55.5	13.5
FE3 M36(28*22)	FE 3	M36	28	22	48	70	55.5	13.5

## Tapping Collet without Cluth 无过载保护攻丝筒夹 (英制)

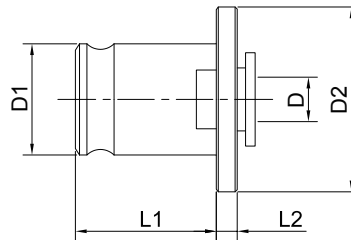

Size	Collet	ANSI	Metric	D	□	D1	D2	L1	L2
0-6" M1.6-M3.5	FE 1	0-6"	M1.6-M3.5	0.141	0.11	19	30	21.5	7
8, 5/32 M4	FE 1	8, 5/32	M4	0.168	0.131	19	30	21.5	7
10, 3/16" M4.5 M5	FE 1	10, 3/16"	M4.5 M5	0.194	0.152	19	30	21.5	7
12, 7/32"	FE 1	12, 7/32"		0.22	0.165	19	30	21.5	7
1/4" M6 M6.3	FE 1	1/4"	M6 M6.3	0.255	0.191	19	30	21.5	7
5/16" M7 M8	FE 1	5/16"	M7 M8	0.318	0.238	19	30	21.5	7
3/8" M10	FE 1	3/8"	M10	0.381	0.286	19	30	21.5	7
7/16" M11	FE 1	7/16"	M11	0.323	0.242	19	30	21.5	7
1/2" M12 M12.5	FE 1	1/2"	M12 M12.5	0.367	0.275	19	30	21.5	7
9/16" M14	FE 1	9/16"	M14	0.429	0.322	19	30	21.5	7
1/8" NPT	FE 1	1/8" NPT	-	0.437	0.328	19	30	21.5	7
5/16" M7 M8	FE 2	5/16"	M7 M8	0.318	0.238	31	48	35	11
3/8" M10	FE 2	3/8"	M10	0.381	0.286	31	48	35	11
7/16" M11	FE 2	7/16"	M11	0.323	0.242	31	48	35	11
1/2" M12 M12.5	FE 2	1/2"	M12 M12.5	0.367	0.275	31	48	35	11
9/16" M14	FE 2	9/16"	M14	0.429	0.322	31	48	35	11
5/8" M16	FE 2	5/8"	M16	0.48	0.36	31	48	35	11
11/16" M18	FE 2	11/16"	M18	0.542	0.406	31	48	35	11
3/4"	FE 2	3/4"	-	0.59	0.442	31	48	35	11
13/16" M20	FE 2	13/16"	M20	0.652	0.489	31	48	35	11
7/8" M22	FE 2	7/8"	M22	0.697	0.523	31	48	35	11
1/4" NPT	FE 2	1/4" NPT	-	0.562	0.421	31	48	35	11
3/8" NPT	FE 2	3/8" NPT	-	0.7	0.531	31	48	35	11
1/2" NPT	FE 2	1/2" NPT	-	0.687	0.515	31	48	35	11
M20									
13/16" M20	FE 3	13/16"	M22	0.652	0.489	48	70	55.5	13.5
7/8" M22	FE 3	7/8"	M24	0.697	0.523	48	70	55.5	13.5
15/16" M24	FE 3	15/16"	M25	0.76	0.57	48	70	55.5	13.5
1" M25	FE 3	1"	M27	0.8	0.6	48	70	55.5	13.5
1-1/8", 1-1/16" M27	FE 3	1-1/8", 1-1/16"	M30	0.896	0.672	48	70	55.5	13.5
1-1/4", 1-3/16 M30	FE 3	1-1/4", 1-3/16	M33	1.021	0.766	48	70	55.5	13.5
1-3/8", 1-5/16 M33	FE 3	1-3/8", 1-5/16	-	1.108	0.831	48	70	55.5	13.5
1/2" NPT	FE 3	1/2" NPT	-	0.687	0.515	48	70	55.5	13.5
3/4" NPT	FE 3	3/4" NPT	-	0.906	0.678	48	70	55.5	13.5
1" NPT	FE 3	1" NPT	-	1.125	0.843	48	70	55.5	13.5

## BT Pull Stud BT 拉钉

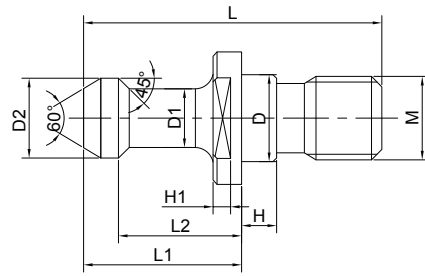

Size	D	D1	D2	M	L	L1	L2	H	H1	Ø
BT30-45	12.5	7	11	M12	43	23	18	4	3.5	45
BT30-60	12.5	7	11	M12	43	23	18	4	3.5	60
BT30-90	12.5	7	11	M12	43	23	18	4	3.5	90
BT40-45	17	10	15	M16	60	35	28	5	4	45
BT40-60	17	10	15	M16	60	35	28	5	4	60
BT40-90	17	10	15	M16	60	35	28	5	4	90
BT50-45	25	17	23	M24	85	45	35	8	8	45
BT50-60	25	17	23	M24	85	45	35	8	8	60
BT50-90	25	17	23	M24	85	45	35	8	8	90
BT30C-45	12.5	7	11	M12	43	23	18	4	3.5	45
BT30C-60	12.5	7	11	M12	43	23	18	4	3.5	60
BT30C-90	12.5	7	11	M12	43	23	18	4	3.5	90
BT40C-45	17	10	15	M16	60	35	28	5	4	45
BT40C-60	17	10	15	M16	60	35	28	5	4	60
BT40C-90	17	10	15	M16	60	35	28	5	4	90
BT50C-45	25	17	23	M24	85	45	35	8	8	45
BT50C-60	25	17	23	M24	85	45	35	8	8	60
BT50C-90	25	17	23	M24	85	45	35	8	8	90
BT30CO-45	12.5	7	11	M12	43	23	18	4	3.5	45
BT30CO-60	12.5	7	11	M12	43	23	18	4	3.5	60
BT30CO-90	12.5	7	11	M12	43	23	18	4	3.5	90
BT40CO-45	17	10	15	M16	60	35	28	5	4	45
BT40CO-60	17	10	15	M16	60	35	28	5	4	60
BT40CO-90	17	10	15	M16	60	35	28	5	4	90
BT50CO-45	25	17	23	M24	85	45	35	8	8	45
BT50CO-60	25	17	23	M24	85	45	35	8	8	60
BT50CO-90	25	17	23	M24	85	45	35	8	8	90

C: Through Hole

O: with O-Ring

Other sizes can be made by request.



## SK Pull Stud SK 拉钉

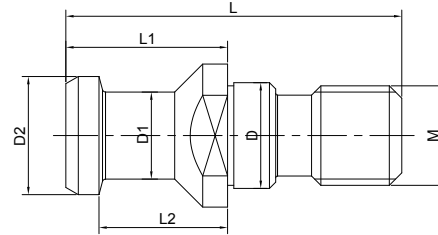

Size	D	D1	D2	M	L	L1	L2
SK-30A	13	9	13	M12	44	24	19
SK-40A	17	14	19	M16	54	26	20
SK-50A	25	21	28	M24	74	34	25
SK-30AO	13	9	13	M12	44	24	19
SK-40AO	17	14	19	M16	54	26	20
SK-50AO	25	21	28	M24	74	34	25
SK-30B	13	9	13	M12	44	24	19
SK-40B	17	14	19	M16	54	26	20
SK-50B	25	21	28	M24	74	34	25

A: Through Hole, without O-Ring  
 B: Not Through Hole, with O-Ring  
 Other sizes can be made by request.

## ISO 7388 Pull Stud ISO 7388 拉钉

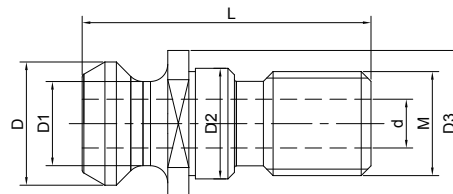

Size	D3	D2	D1	D	M	L	d
ISO7388-40A	23	17	14	19	M16	54	7
ISO7388-50A	38	25	21	28	M24	74	10
ISO7388-40B	22.5	17	12.95	18.95	M16	44.4	7.35
ISO7388-50B	37	25	19.6	29.1	M24	66.55	11.55

### CAT Pull Stud

### CAT 拉钉

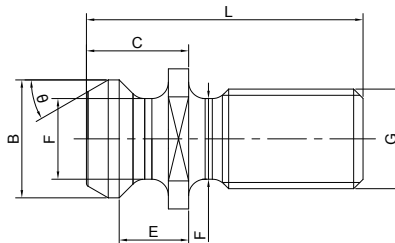

Size	Type	G	$\theta$	L	B	C	E	F
CAT40C-45	A	5/8"-11	45	1.5	0.74	0.64	0.44	0.49
CAT50C-45	A	1"-8	45	2.3	1.14	1	0.7	0.82

### CAT Pull Stud

### CAT 拉钉

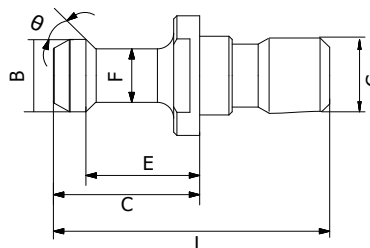

Size	Type	G	$\theta$	L	B	C	E	F
BT-CAT40C-45	B	5/8"-11	45	2.25	0.59	1.266	0.99	0.394
BT-CAT40C-90	B	5/8"-11	90	2.25	0.59	1.266	0.99	0.394
BT-CAT50C-45	B	1"-8	45	3.094	0.906	1.771	1.378	0.669
BT-CAT50C-90	B	1"-8	90	3.094	0.906	1.771	1.378	0.669

### OTT Pull Stud

### OTT 拉杆

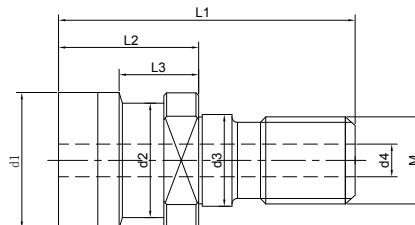

Size	M	d1	d2	d3	d4	l3	l2	l1
OTT40	M16	25	21.1	17	7	13.6	25.1	53
OTT50	M24	39.6	30.2	25	7	13.3	25.1	65.1

## ISO Pull Stud ISO 拉钉

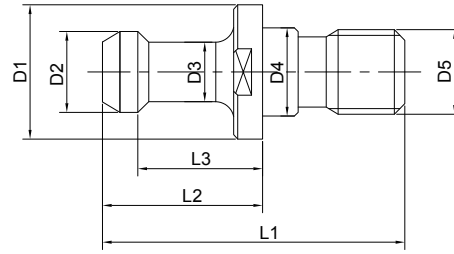

Size	L1	L2	L3	D1	D2	D3	D4	D5
ISO20	26	12	9	12	9	6	8.5	M8
ISO25	28	12	9	13	11	7	8.5	M8
ISO30	44	24	19	17	13	9	13	M12

## Mazak Pull Stud 马扎克拉钉

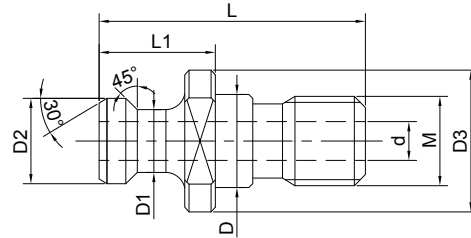

Size	L	L1	D2	D1	D3	D	d	M
Mazak-BT40C	44.1	19.1	18.8	12.45	22	17	7	M16
Mazak-BT50C	65.2	25.2	29	20.83	37	25	10	M24
Mazak-BT40CO	44.1	19.1	18.8	12.45	22	17	7	M16
Mazak-BT50CO	65.2	25.2	29	20.83	37	25	10	M24

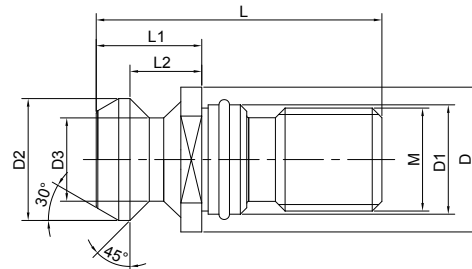

Size	D	D1	D2	D3	L	L1	L2	M
Mazak-CAT40C	22	17	18.79	12.5	41.25	16.25	11.17	M16
Mazak-CAT50C	35.6	25	28.95	20.82	65.4	25.4	17.78	M24
Mazak-CAT40CO	22	17	18.79	12.5	41.25	16.25	11.17	M16
Mazak-CAT50CO	35.6	25	28.95	20.82	65.4	25.4	17.78	M24

## ER Nut

### ER 压帽



## UM

Size	D	d	L	M
ER16UM	32	26	17.5	M22X1.5
ER20UM	35	29	19	M25X1.5
ER25UM	42	36	20	M32X1.5
ER32UM	50	44	22.5	M40X1.5
ER40UM	63	57	25.5	M50X1.5
ER50UM	78	71	35.5	M64X2

## Hex

Size	D	d	L	M
ER11A	19	17	11.3	M14X0.75
ER16A	28	25	17.5	M22X1.5
ER20A	34	30	19	M25X1.5

## Mini

Size	D	d	L	M
ER8M	12	10	10	M10X0.75
ER11M	16	12	12	M13X0.75
ER16M	22	17.2	18	M19X1
ER20M	28	22.5	19	M24X1
ER25M	35	28.6	20	M30X1

**ER Nut**  
**ER 压帽**

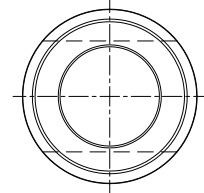
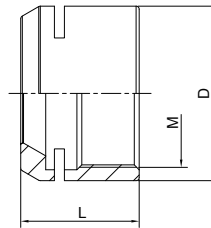

**MS**

Size	D	L	M
ER11MS	16	12	M13*0.75
ER16MS	22	17	M19*1.0
ER20MS	28	19	M24*1.0
ER25MS	35	20	M30*1.0

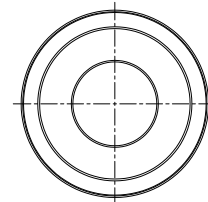
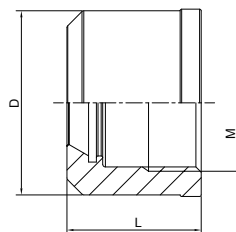

**GER**

Size	D	L	M
GER16	27	19	TM22*1.5
GER20	30	22	TM26*1.5
GER25	40	25.9	TM32*1.5
GER32	48	24.5	TM40*1.5

## ER Sealed Nut ERS 止水压帽

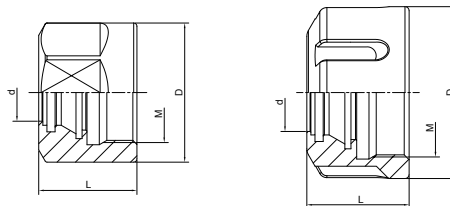

### Sealed Nut

Size	D	d	L	M
ERS16	32	11	22.5	M22×1.5
ERS20	34	14	24	M25×1.5
ERS25	42	19	25	M32×1.5
ERS32	50	24	27.5	M40×1.5
ERS40	63	30	30.5	M50×1.5

## Sealing Disc 止水垫圈

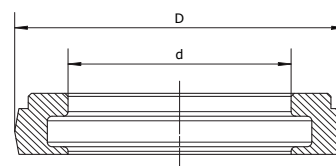

Size	d	D	Size	d	D	Size	d	D	Size	d	D
ERS16-1	1	13	ERS20-11	11	16	ERS32-4	4	27	ERS40-6	6	33.5
ERS16-2	2	13	ERS20-12	12	16	ERS32-5	5	27	ERS40-7	7	33.5
ERS16-3	3	13	ERS20-13	13	16	ERS32-6	6	27	ERS40-8	8	33.5
ERS16-4	4	13				ERS32-7	7	27	ERS40-9	9	33.5
ERS16-5	5	13	ERS25-2	2	20.7	ERS32-8	8	27	ERS40-10	10	33.5
ERS16-6	6	13	ERS25-3	3	20.7	ERS32-9	9	27	ERS40-11	11	33.5
ERS16-7	7	13	ERS25-4	4	20.7	ERS32-10	10	27	ERS40-12	12	33.5
ERS16-8	8	13	ERS25-5	5	20.7	ERS32-11	11	27	ERS40-13	13	33.5
ERS16-9	9	13	ERS25-6	6	20.7	ERS32-12	12	27	ERS40-14	14	33.5
ERS16-10	10	13	ERS25-7	7	20.7	ERS32-13	13	27	ERS40-15	15	33.5
			ERS25-8	8	20.7	ERS32-14	14	27	ERS40-16	16	33.5
ERS20-1	1	16	ERS25-9	9	20.7	ERS32-15	15	27	ERS40-17	17	33.5
ERS20-2	2	16	ERS25-10	10	20.7	ERS32-16	16	27	ERS40-18	18	33.5
ERS20-3	3	16	ERS25-11	11	20.7	ERS32-17	17	27	ERS40-19	19	33.5
ERS20-4	4	16	ERS25-12	12	20.7	ERS32-18	18	27	ERS40-20	20	33.5
ERS20-5	5	16	ERS25-13	13	20.7	ERS32-19	19	27	ERS40-21	21	33.5
ERS20-6	6	16	ERS25-14	14	20.7	ERS32-20	20	27	ERS40-22	22	33.5
ERS20-7	7	16	ERS25-15	15	20.7				ERS40-23	23	33.5
ERS20-8	8	16	ERS25-16	16	20.7	ERS40-3	3	33.5	ERS40-24	24	33.5
ERS20-9	9	16	ERS32-2	2	27	ERS40-4	4	33.5	ERS40-25	25	33.5
ERS20-10	10	16	ERS32-3	3	27	ERS40-5	5	33.5	ERS40-26	26	33.5

## OZ Nut

### OZ 压帽

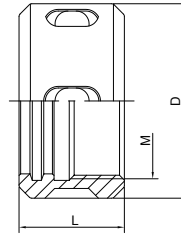

Size	D	L	M
OZ6	18	14	M14X1.0
OZ8	26	19	M20X1.5
OZ10	30	19	M22X1.5
OZ12	35	20	M27X1.5
OZ16	43	24	M33X1.5
OZ20	50	28	M42X2.0
OZ25	60	30	M48X2.0
OZ32	72	33.5	M60X2.5
OZ40	85	37	M68X2.5
OZ50	100	43	M80X2.5

## SKS Nut

### SKS 无风阻压帽

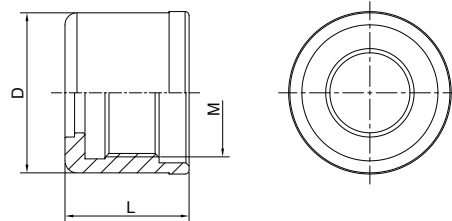

Size	D	L	M
SK06	19.5	21	M15.5*1.0
SK10	27.1	24	M21.5*1.0
SK16	40	31	M32*1.5
SK20	48	24	M40*1
SK25	55	37	M45*1.5

## ER Spanner

### ER 扳手

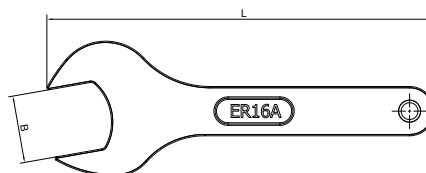

### Hex

Size	B	L	Nut
ER11A	17	110	ER11-A
ER16A	25	120	ER16-A
ER20A	30	130	ER20-A

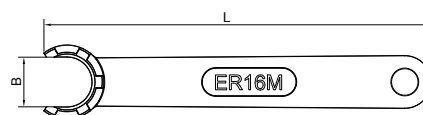

### Mini

Size	B	L	Nut
ER8M	12.9	70	ER8-M
ER11M	16.7	90	ER11-M
ER16M	22.4	110	ER16-M
ER20M	28.9	120	ER20-M
ER25M	35.8	130	ER25-M



**ER Spanner**  
**ER 扳手**

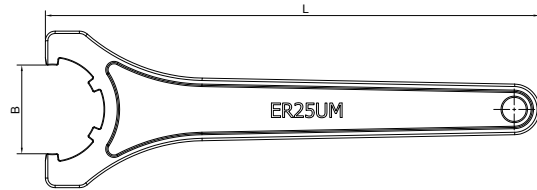

**UM**

Size	B	L	Nut
ER16UM	26	180	ER16-UM
ER20UM	29	190	ER20-UM
ER25UM	37	210	ER25-UM
ER32UM	45	250	ER32-UM
ER40UM	58	290	ER40-UM
ER50UM	71	350	ER50-UM

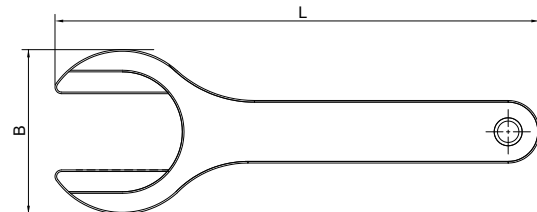

**MS**

Size	B	L
ER8MS	19	76
ER11MS	10	100
ER16MS	15	130
ER20MS	18	160
ER25MS	23	200

## Hook Spanner

### 勾头扳手



Size	L	Range
C20	214	50-55
C25	214	56-61
C32	235	68-73
C42	261	88-96

## Ball Spanner

### 滚珠扳手

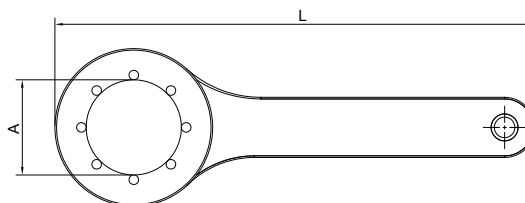

Size	A	L
SKS06C19	19	150
SKS10C27	27	150
SKS16C30	30	150
SKS20C35	35	170
SKS16C40	40	180
SKS20C48	48	210
SKS25C55	55	260

## Reduction Sleeve for Boring Bar Holder

镗刀减径套

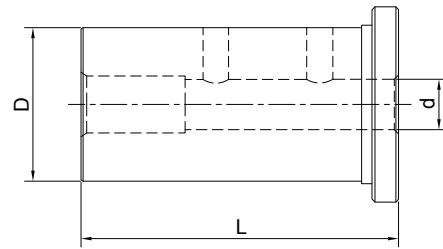

Size	d	D	L
SL25-06	6	25	46
SL25-08	8	25	46
SL25-10	10	25	46
SL25-12	12	25	46
SL32-06	6	32	56
SL32-08	8	32	56
SL32-10	10	32	56
SL32-12	12	32	56
SL40-06	6	40	71
SL40-08	8	40	71
SL40-10	10	40	71
SL40-12	12	40	71

## Reduction Sleeve for Boring Bar Holder

镗刀减径套

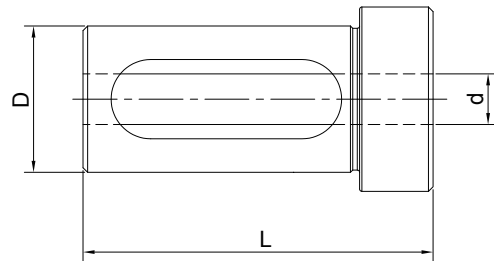

Size	d	D	L
SL25-16	16	25	46
SL25-20	20	25	46
SL32-16	16	32	56
SL32-20	20	32	56
SL32-25	25	32	56
SL40-16	16	40	71
SL40-20	20	40	71
SL40-25	25	40	71
SL40-32	32	40	71

## Tool Holder Bushing B Type

### 车床刀套 B 型

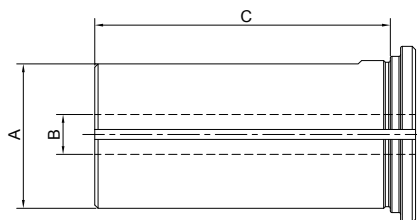

Size	A(OD)	B(ID)	C
B 3/4"x1/4"	3/4"	1/4	1-1/2
B 3/4"x5/16"	3/4"	5/16	1-1/2
B 3/4"x3/8"	3/4"	3/8	1-1/2
B 3/4"x1/2"	3/4"	1/2	1-1/2
B 1"x5/16"	1"	5/16	1-3/4
B 1"x3/8"	1"	3/8	1-3/4
B 1"x1/2"	1"	1/2	1-3/4
B 1"x5/8"	1"	5/8	1-3/4
B 1"x3/4"	1"	3/4	1-3/4
B 1-1/4"x3/8"	1-1/4"	3/8	2-1/8
B 1-1/4"x1/2"	1-1/4"	1/2	2-1/8
B 1-1/4"x5/8"	1-1/4"	5/8	2-1/8
B 1-1/4"x3/4"	1-1/4"	3/4	2-1/8
B 1-1/4"x7/8"	1-1/4"	7/8	2-1/8
B 1-1/4"x1"	1-1/4"	1	2-1/8
B 1-1/2"x3/8"	1-1/2"	3/8	2-1/2
B 1-1/2"x1/2"	1-1/2"	1/2	2-1/2
B 1-1/2"x5/8"	1-1/2"	5/8	2-1/2
B 1-1/2"x3/4"	1-1/2"	3/4	2-1/2
B 1-1/2"x7/8"	1-1/2"	7/8	2-1/2
B 1-1/2"x1"	1-1/2"	1	2-1/2
B 1-1/2"x1-1/4"	1-1/2"	1-1/4	2-1/2
B 1-3/4"x1/2"	1-3/4"	1/2	3
B 1-3/4"x5/8"	1-3/4"	5/8	3
B 1-3/4"x3/4"	1-3/4"	3/4	3
B 1-3/4"x7/8"	1-3/4"	7/8	3
B 1-3/4"x1"	1-3/4"	1	3
B 1-3/4"x1-1/4"	1-3/4"	1-1/4	3
B 1-3/4"x1-1/2"	1-3/4"	1-1/2	3

Size	A(OD)	B(ID)	C
B 2"x1/2"	2"	1/2	3-1/2
B 2"x5/8"	2"	5/8	3-1/2
B 2"x3/4"	2"	3/4	3-1/2
B 2"x7/8"	2"	7/8	3-1/2
B 2"x1"	2"	1	3-1/2
B 2"x1-1/4"	2"	1-1/4	3-1/2
B 2"x1-1/2"	2"	1-1/2	3-1/2
B 2"x1-3/4"	2"	1-3/4	3-1/2
B 2-1/2"x1/2"	2-1/2"	1/2	4
B 2-1/2"x5/8"	2-1/2"	5/8	4
B 2-1/2"x3/4"	2-1/2"	3/4	4
B 2-1/2"x7/8"	2-1/2"	7/8	4
B 2-1/2"x1"	2-1/2"	1	4
B 2-1/2"x1-1/4"	2-1/2"	1-1/4	4
B 2-1/2"x1-1/2"	2-1/2"	1-1/2	4
B 2-1/2"x1-3/4"	2-1/2"	1-3/4	4
B 2-1/2"x2"	2-1/2"	2	4
B 2-1/2"x2-1/4"	2-1/2"	2-1/4	4
B 3"x1-1/4"	3"	1	4-1/2
B 3"x1-1/2"	3"	1-1/4	4-1/2
B 3"x1-3/4"	3"	1-1/2	4-1/2
B 3-1/2"x1/2"	3"	1-3/4	4-1/2
B 3-1/2"x5/8"	3"	2	4-1/2
B 3-1/2"x3/4"	3"	2-1/4	4-1/2
B 3-1/2"x7/8"	3"	2-1/2	4-1/2
B 3-1/2"x1"	3-1/2"	1	5-1/4
B 3-1/2"x1-1/4"	3-1/2"	1-1/4	5-1/4
B 3-1/2"x1-1/2"	3-1/2"	1-1/2	5-1/4
B 3-1/2"x1-3/4"	3-1/2"	1-3/4	5-1/4
B 3-1/2"x2"	3-1/2"	2	5-1/4
B 3-1/2"x2-1/4"	3-1/2"	2-1/4	5-1/4
B 3-1/2"x2-1/2"	3-1/2"	2-1/2	5-1/4
B 3-1/2"x3"	3-1/2"	3	5-1/4

## Tool Holder Bushing J Type 车床刀套 J 型

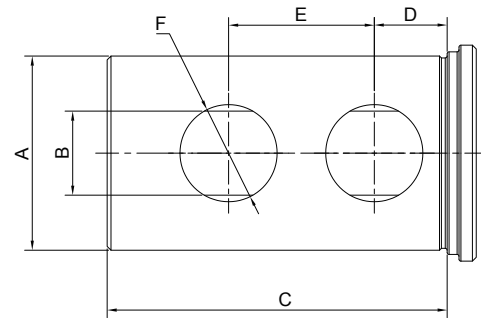

Size	A(OD)	B(ID)	C	D	E	F	Holes No.
J 3/4"x1/4"	3/4"	1/4	1-1/2	3/9	13/16	3/8	2
J 3/4"x5/16"	3/4"	5/16	1-1/2	3/9	13/16	3/8	2
J 3/4"x3/8"	3/4"	3/8	1-1/2	3/9	13/16	3/8	2
J 3/4"x1/2"	3/4"	1/2	1-1/2	3/9	13/16	3/8	2
J 1"x3/8"	1"	3/8	1-3/4	7/16	7/8	5/8	2
J 1"x1/2"	1"	1/2	1-3/4	7/16	7/8	5/8	2
J 1"x5/8"	1"	5/8	1-3/4	7/16	7/8	5/8	2
J 1"x3/4"	1"	3/4	1-3/4	7/16	7/8	5/8	2
J 1-1/4"x3/8"	1-1/4"	3/8	2-1/8	5/8	1	3/4	2
J 1-1/4"x1/2"	1-1/4"	1/2	2-1/8	5/8	1	3/4	2
J 1-1/4"x5/8"	1-1/4"	5/8	2-1/8	5/8	1	3/4	2
J 1-1/4"x3/4"	1-1/4"	3/4	2-1/8	5/8	1	3/4	2
J 1-1/4"x7/8"	1-1/4"	7/8	2-1/8	5/8	1	3/4	2
J 1-1/4"x1"	1-1/4"	1	2-1/8	5/8	1	3/4	2
J 1-1/2"x3/8"	1-1/2"	3/8	2-1/2	11/16	1-1/8	7/8	2
J 1-1/2"x1/2"	1-1/2"	1/2	2-1/2	11/16	1-1/8	7/8	2
J 1-1/2"x5/8"	1-1/2"	5/8	2-1/2	11/16	1-1/8	7/8	2
J 1-1/2"x3/4"	1-1/2"	3/4	2-1/2	11/16	1-1/8	7/8	2
J 1-1/2"x7/8"	1-1/2"	7/8	2-1/2	11/16	1-1/8	7/8	2
J 1-1/2"x1"	1-1/2"	1	2-1/2	11/16	1-1/8	7/8	2
J 1-1/2"x1-1/4"	1-1/2"	1-1/4	2-1/2	11/16	1-1/8	7/8	2
J 1-3/4"x1/2"	1-3/4"	1/2	3	3/4	1-1/4	7/8	2
J 1-3/4"x5/8"	1-3/4"	5/8	3	3/4	1-1/4	7/8	2
J 1-3/4"x3/4"	1-3/4"	3/4	3	3/4	1-1/4	7/8	2
J 1-3/4"x7/8"	1-3/4"	7/8	3	3/4	1-1/4	7/8	2
J 1-3/4"x1"	1-3/4"	1	3	3/4	1-1/4	7/8	2
J 1-3/4"x1-1/4"	1-3/4"	1-1/4	3	3/4	1-1/4	7/8	2
J 1-3/4"x1-1/2"	1-3/4"	1-1/2	3	3/4	1-1/4	7/8	2
J 2"x1/2"	2"	1/2	3-1/2	3/4	1-1/2	1	2
J 2"x5/8"	2"	5/8	3-1/2	3/4	1-1/2	1	2
J 2"x3/4"	2"	3/4	3-1/2	3/4	1-1/2	1	2
J 2"x7/8"	2"	7/8	3-1/2	3/4	1-1/2	1	2
J 2"x1"	2"	1	3-1/2	3/4	1-1/2	1	2

## Tool Holder Bushing J Type

### 车床刀套 J 型

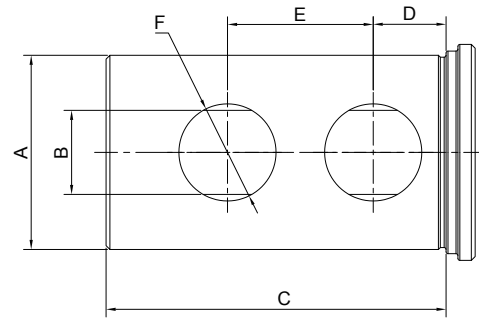

Size	A(OD)	B(ID)	C	D	E	F	Holes No.
J 2"x1-1/4"	2"	1-1/4	3-1/2	3/4	1-1/2	1	2
J 2"x1-1/2"	2"	1-1/2	3-1/2	3/4	1-1/2	1	2
J 2"x1-3/4"	2"	1-3/4	3-1/2	3/4	1-1/2	1	2
J 2-1/2"x1/2"	2-1/2"	1/2	4	7/8	1-3/4	1-1/4	2
J 2-1/2"x5/8"	2-1/2"	5/8	4	7/8	1-3/4	1-1/4	2
J 2-1/2"x3/4"	2-1/2"	3/4	4	7/8	1-3/4	1-1/4	2
J 2-1/2"x7/8"	2-1/2"	7/8	4	7/8	1-3/4	1-1/4	2
J 2-1/2"x1"	2-1/2"	1	4	7/8	1-3/4	1-1/4	2
J 2-1/2"x1-1/4"	2-1/2"	1-1/4	4	7/8	1-3/4	1-1/4	2
J 2-1/2"x1-1/2"	2-1/2"	1-1/2	4	7/8	1-3/4	1-1/4	2
J 2-1/2"x1-3/4"	2-1/2"	1-3/4	4	7/8	1-3/4	1-1/4	2
J 2-1/2"x2"	2-1/2"	2	4	7/8	1-3/4	1-1/4	2
J 2-1/2"x2-1/4"	2-1/2"	2-1/4	4	7/8	1-3/4	1-1/4	2
J 3"x1"	3"	1	4-1/2	1	2	1-1/4	4
J 3"x1-1/4"	3"	1-1/4	4-1/2	1	2	1-1/4	4
J 3"x1-1/2"	3"	1-1/2	4-1/2	1	2	1-1/4	4
J 3"x1-3/4"	3"	1-3/4	4-1/2	1	2	1-1/4	4
J 3"x2"	3"	2	4-1/2	1	2	1-1/4	4
J 3"x2-1/4"	3"	2-1/4	4-1/2	1	2	1-1/4	4
J 3"x2-1/2"	3"	2-1/2	4-1/2	1	2	1-1/4	4
J 3-1/2"x1"	3-1/2"	1	5-1/4	1-1/4	2-1/2	1-1/4	4
J 3-1/2"x1-1/4"	3-1/2"	1-1/4	5-1/4	1-1/4	2-1/2	1-1/4	4
J 3-1/2"x1-1/2"	3-1/2"	1-1/2	5-1/4	1-1/4	2-1/2	1-1/4	4
J 3-1/2"x1-3/4"	3-1/2"	1-3/4	5-1/4	1-1/4	2-1/2	1-1/4	4
J 3-1/2"x2"	3-1/2"	2	5-1/4	1-1/4	2-1/2	1-1/4	4
J 3-1/2"x2-1/4"	3-1/2"	2-1/4	5-1/4	1-1/4	2-1/2	1-1/4	4
J 3-1/2"x2-1/2"	3-1/2"	2-1/2	5-1/4	1-1/4	2-1/2	1-1/4	4
J 3-1/2"x3"	3-1/2"	3	5-1/4	1-1/4	2-1/2	1-1/4	4

## Tool Holder Bushing C Type 车床刀套 C 型

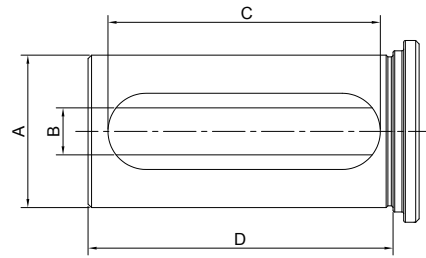

Size	A(OD)	B(ID)	C	D	Holes No.
C 3/4"x1/4"	3/4"	1/4	1-1/2	2	1
C 3/4"x5/16"	3/4"	5/16	1-1/2	2	1
C 3/4"x3/8"	3/4"	3/8	1-1/2	2	1
C 3/4"x1/2"	3/4"	1/2	1-1/2	2	1
C 1"x1/4"	1"	1/4	2-3/8	2-3/4	1
C 1"x5/16"	1"	5/16	2-3/8	2-3/4	1
C 1"x3/8"	1"	3/8	2-3/8	2-3/4	1
C 1"x1/2"	1"	1/2	2-3/8	2-3/4	1
C 1"x5/8"	1"	5/8	2-3/8	2-3/4	1
C 1"x3/4"	1"	3/4	2-3/8	2-3/4	1
C 1-1/4"x3/8"	1-1/4"	3/8	2-3/4	3-1/4	1
C 1-1/4"x1/2"	1-1/4"	1/2	2-3/4	3-1/4	1
C 1-1/4"x5/8"	1-1/4"	5/8	2-3/4	3-1/4	1
C 1-1/4"x3/4"	1-1/4"	3/4	2-3/4	3-1/4	1
C 1-1/4"x7/8"	1-1/4"	7/8	2-3/4	3-1/4	1
C 1-1/4"x1"	1-1/4"	1	2-3/4	3-1/4	1
C 1-1/2"x3/8"	1-1/2"	3/8	3	3-3/8	1
C 1-1/2"x1/2"	1-1/2"	1/2	3	3-3/8	1
C 1-1/2"x5/8"	1-1/2"	5/8	3	3-3/8	1
C 1-1/2"x3/4"	1-1/2"	3/4	3	3-3/8	1
C 1-1/2"x7/8"	1-1/2"	7/8	3	3-3/8	1
C 1-1/2"x1"	1-1/2"	1	3	3-3/8	1
C 1-1/2"x1-1/4"	1-1/2"	1-1/4	3	3-3/8	1
C 1-3/4"x1/2"	1-3/4"	1/2	3-1/8	3-1/2	1
C 1-3/4"x5/8"	1-3/4"	5/8	3-1/8	3-1/2	1
C 1-3/4"x3/4"	1-3/4"	3/4	3-1/8	3-1/2	1
C 1-3/4"x7/8"	1-3/4"	7/8	3-1/8	3-1/2	1
C 1-3/4"x1"	1-3/4"	1	3-1/8	3-1/2	1
C 1-3/4"x1-1/4"	1-3/4"	1-1/4	3-1/8	3-1/2	1
C 1-3/4"x1-1/2"	1-3/4"	1-1/2	3-1/8	3-1/2	1
C 2"x1-1/2"	2"	1/2	3-5/8	4	1
C 2"x5/8"	2"	5/8	3-5/8	4	1
C 2"x3/4"	2"	3/4	3-5/8	4	1
C 2"x1"	2"	1	3-5/8	4	1

## Tool Holder Bushing C Type

### 车床刀套 C 型

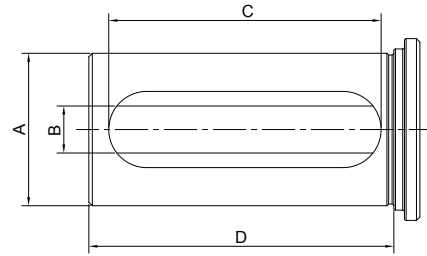

Size	A(OD)	B(ID)	C	D	Holes No.
C 2"x1-1/4"	2"	1-1/4	3-5/8	4	1
C 2"x1-1/2"	2"	1-1/2	3-5/8	4	1
C 2"x1-3/4"	2"	1-3/4	3-5/8	4	1
C 2-1/2"x1/2"	2-1/2"	1/2	4-1/8	4-1/2	1 or 2
C 2-1/2"x5/8"	2-1/2"	5/8	4-1/8	4-1/2	1 or 2
C 2-1/2"x3/4"	2-1/2"	3/4	4-1/8	4-1/2	1 or 2
C 2-1/2"x7/8"	2-1/2"	7/8	4-1/8	4-1/2	1 or 2
C 2-1/2"x1"	2-1/2"	1	4-1/8	4-1/2	1 or 2
C 2-1/2"x1-1/4"	2-1/2"	1-1/4	4-1/8	4-1/2	1 or 2
C 2-1/2"x1-1/2"	2-1/2"	1-1/2	4-1/8	4-1/2	1 or 2
C 2-1/2"x1-3/4"	2-1/2"	1-3/4	4-1/8	4-1/2	1 or 2
C 2-1/2"x2"	2-1/2"	2	4-1/8	4-1/2	1 or 2
C 2-1/2"x2-1/4"	2-1/2"	2-1/4	4-1/8	4-1/2	1 or 2
C 3"x1"	3"	1	4-5/8	5	1 or 2
C 3"x1-1/4"	3"	1-1/4	4-5/8	5	1 or 2
C 3"x1-1/2"	3"	1-1/2	4-5/8	5	1 or 2
C 3"x1-3/4"	3"	1-3/4	4-5/8	5	1 or 2
C 3"x2"	3"	2	4-5/8	5	1 or 2
C 3"x2-1/4"	3"	2-1/4	4-5/8	5	1 or 2
C 3"x2-1/2"	3"	2-1/2	4-5/8	5	1 or 2
C 3-1/2"x1"	3-1/2"	1	5	5-3/4	1 or 2
C 3-1/2"x1x1/4"	3-1/2"	1-1/4	5	5-3/4	1 or 2
C 3-1/2"x1-1/2"	3-1/2"	1-1/2	5	5-3/4	1 or 2
C 3-1/2"x1-3/4"	3-1/2"	1-3/4	5	5-3/4	1 or 2
C 3-1/2"x2"	3-1/2"	2	5	5-3/4	1 or 2
C 3-1/2"x2-1/4"	3-1/2"	2-1/4	5	5-3/4	1 or 2
C 3-1/2"x2-1/2"	3-1/2"	2-1/2	5	5-3/4	1 or 2
C 3-1/2"x3"	3-1/2"	3	5	5-3/4	1 or 2



## Tool Holder Bushing CV Type 车床刀套 CV 型

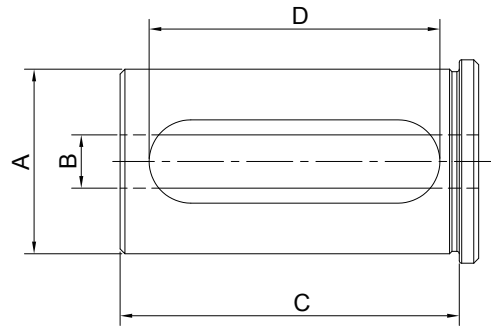

Size	A(OD)	B(ID)	C	D
CV 1-1/4"x1/4"	1-1/4"	1/4	2.36(60mm)	1.97(50mm)
CV 1-1/4"x3/8"	1-1/4"	3/8	2.36(60mm)	1.97(50mm)
CV 1-1/4"x1/2"	1-1/4"	1/2	2.36(60mm)	1.97(50mm)
CV 1-1/4"x5/8"	1-1/4"	5/8	2.36(60mm)	1.97(50mm)
CV 1-1/4"x3/4"	1-1/4"	3/4	2.36(60mm)	1.97(50mm)
CV 1-1/4"x7/8"	1-1/4"	7/8	2.36(60mm)	1.97(50mm)
CV 1-1/4"x1"	1-1/4"	1	2.36(60mm)	1.97(50mm)
CV 1-1/2"x1/4"	1-1/2"	1/4	2.76(70mm)	2.36(60mm)
CV 1-1/2"x3/8"	1-1/2"	3/8	2.76(70mm)	2.36(60mm)
CV 1-1/2"x1/2"	1-1/2"	1/2	2.76(70mm)	2.36(60mm)
CV 1-1/2"x5/8"	1-1/2"	5/8	2.76(70mm)	2.36(60mm)
CV 1-1/2"x3/4"	1-1/2"	3/4	2.76(70mm)	2.36(60mm)
CV 1-1/2"x7/8"	1-1/2"	7/8	2.76(70mm)	2.36(60mm)
CV 1-1/2"x1"	1-1/2"	1	2.76(70mm)	2.36(60mm)
CV 1-1/2"x1/4"	1-1/2"	1-1/4	2.76(70mm)	2.36(60mm)

## Tool Holder Bushing DD Type

### 车床刀套 DD 型

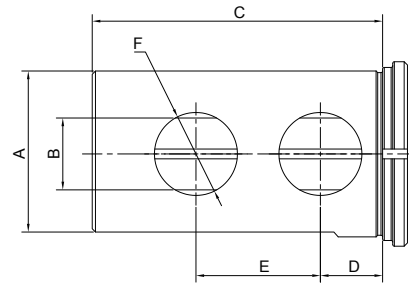

Size	A(OD)	B(ID)	C	D	E	F	Holes No.
DD 1-1/2"x3/8"	1-1/2"	3/8	2-1/2	11/16	1-1/8	7/8	2
DD 1-1/2"x1/2"	1-1/2"	1/2	2-1/2	11/16	1-1/8	7/8	2
DD 1-1/2"x5/8"	1-1/2"	5/8	2-1/2	11/16	1-1/8	7/8	2
DD 1-1/2"x3/4"	1-1/2"	3/4	2-1/2	11/16	1-1/8	7/8	2
DD 1-1/2"x7/8"	1-1/2"	7/8	2-1/2	11/16	1-1/8	7/8	2
DD 1-1/2"x1"	1-1/2"	1	2-1/2	11/16	1-1/8	7/8	2
DD 1-1/2"x1-1/4"	1-1/2"	1-1/4	2-1/2	11/16	1-1/8	7/8	2
DD 1-3/4"x1/2"	1-3/4"	1/2	3	3/4	1-1/4	7/8	2
DD 1-3/4"x5/8"	1-3/4"	5/8	3	3/4	1-1/4	7/8	2
DD 1-3/4"x3/4"	1-3/4"	3/4	3	3/4	1-1/4	7/8	2
DD 1-3/4"x7/8"	1-3/4"	7/8	3	3/4	1-1/4	7/8	2
DD 1-3/4"x1"	1-3/4"	1	3	3/4	1-1/4	7/8	2
DD 1-3/4"x1-1/4"	1-3/4"	1-1/4	3	3/4	1-1/4	7/8	2
DD 1-3/4"x1-1/2"	1-3/4"	1-1/2	3	3/4	1-1/4	7/8	2
DD 2"x1/2"	2"	1/2	3-1/2	3/4	1-1/2	1	2
DD 2"x5/8"	2"	5/8	3-1/2	3/4	1-1/2	1	2
DD 2"x3/4"	2"	3/4	3-1/2	3/4	1-1/2	1	2
DD 2"x7/8"	2"	7/8	3-1/2	3/4	1-1/2	1	2
DD 2"x1"	2"	1	3-1/2	3/4	1-1/2	1	2
DD 2"x1-1/4"	2"	1-1/4	3-1/2	3/4	1-1/2	1	2
DD 2"x1-1/2"	2"	1-1/2	3-1/2	3/4	1-1/2	1	2
DD 2"x1-3/4"	2"	1-3/4	3-1/2	3/4	1-1/2	1	2
DD 2-1/2"x1/2"	2-1/2"	1/2	4	7/8	1-3/4	1-1/4	2
DD 2-1/2"x5/8"	2-1/2"	5/8	4	7/8	1-3/4	1-1/4	2
DD 2-1/2"x3/4"	2-1/2"	3/4	4	7/8	1-3/4	1-1/4	2
DD 2-1/2"x7/8"	2-1/2"	7/8	4	7/8	1-3/4	1-1/4	2
DD 2-1/2"x1"	2-1/2"	1	4	7/8	1-3/4	1-1/4	2
DD 2-1/2"x1-1/4"	2-1/2"	1-1/4	4	7/8	1-3/4	1-1/4	2
DD 2-1/2"x1-1/2"	2-1/2"	1-1/2	4	7/8	1-3/4	1-1/4	2
DD 2-1/2"x1-3/4"	2-1/2"	1-3/4	4	7/8	1-3/4	1-1/4	2
DD 2-1/2"x2"	2-1/2"	2	4	7/8	1-3/4	1-1/4	2
DD 2-1/2"x2-1/4"	2-1/2"	2-1/4	4	7/8	1-3/4	1-1/4	2

## Tool Holder Bushing DD Type 车床刀套 DD 型

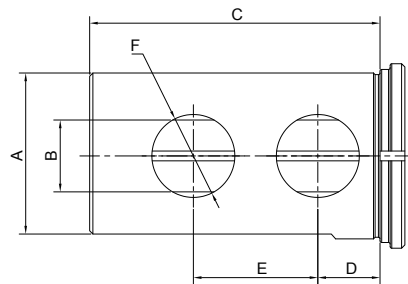

Size	A(OD)	B(ID)	C	D	E	F	Holes No.
DD 3"x1"	3"	1	4-1/2	1	2	1-1/4	4
DD 3"x1-1/4"	3"	1-1/4	4-1/2	1	2	1-1/4	4
DD 3"x1-1/2"	3"	1-1/2	4-1/2	1	2	1-1/4	4
DD 3"x1-3/4"	3"	1-3/4	4-1/2	1	2	1-1/4	4
DD 3"x2"	3"	2	4-1/2	1	2	1-1/4	4
DD 3"x2-1/4"	3"	2-1/4	4-1/2	1	2	1-1/4	4
DD 3"x2-1/2"	3"	2-1/2	4-1/2	1	2	1-1/4	4
DD 3-1/2"x1"	3-1/2"	1	5-1/4	1-1/4	2-1/2	1-1/4	4
DD 3-1/2"x1-1/4"	3-1/2"	1-1/4	5-1/4	1-1/4	2-1/2	1-1/4	4
DD 3-1/2"x1-1/2"	3-1/2"	1-1/2	5-1/4	1-1/4	2-1/2	1-1/4	4
DD 3-1/2"x1-3/4"	3-1/2"	1-3/4	5-1/4	1-1/4	2-1/2	1-1/4	4
DD 3-1/2"x2"	3-1/2"	2	5-1/4	1-1/4	2-1/2	1-1/4	4
DD 3-1/2"x2-1/4"	3-1/2"	2-1/4	5-1/4	1-1/4	2-1/2	1-1/4	4
DD 3-1/2"x2-1/2"	3-1/2"	2-1/2	5-1/4	1-1/4	2-1/2	1-1/4	4
DD 3-1/2"x3"	3-1/2"	3	5-1/4	1-1/4	2-1/2	1-1/4	4

## Tool Holder Bushing Z Type

### 车床刀套 Z 型

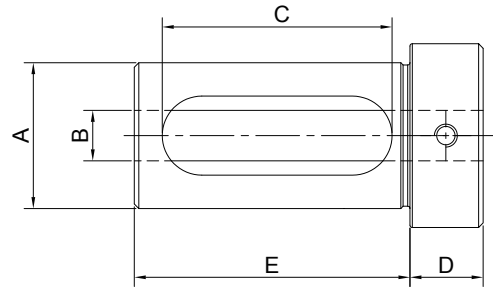

Size	A(OD)	B(ID)	C	D	Holes No.
Z 3/4"x1/4"	3/4"	1/4	2-3/8	1/2	2-1/2
Z 3/4"x5/16"	3/4"	5/16	2-3/8	1/2	2-1/2
Z 3/4"x3/8"	3/4"	3/8	2-3/8	1/2	2-1/2
Z 3/4"x1/2"	3/4"	1/2	2-3/8	1/2	2-1/2
Z 1"x1/4"	1"	1/4	2-3/8	1/2	2-3/4
Z 1"x5/16"	1"	5/16	2-3/8	1/2	2-3/4
Z 1"x3/8"	1"	3/8	2-3/8	1/2	2-3/4
Z 1"x1/2"	1"	1/2	2-3/8	1/2	2-3/4
Z 1"x5/8"	1"	5/8	2-3/8	1/2	2-3/4
Z 1"x3/4"	1"	3/4	2-3/8	1/2	2-3/4
Z 1-1/4"x3/8"	1-1/4"	3/8	2-5/8	5/8	3
Z 1-1/4"x1/2"	1-1/4"	1/2	2-5/8	5/8	3
Z 1-1/4"x5/8"	1-1/4"	5/8	2-5/8	5/8	3
Z 1-1/4"x3/4"	1-1/4"	3/4	2-5/8	5/8	3
Z 1-1/4"x7/8"	1-1/4"	7/8	2-5/8	5/8	3
Z 1-1/4"x1"	1-1/4"	1	2-5/8	5/8	3
Z 1-1/2"x3/8"	1-1/2"	3/8	2-7/8	3/4	3-1/4
Z 1-1/2"x1/2"	1-1/2"	1/2	2-7/8	3/4	3-1/4
Z 1-1/2"x5/8"	1-1/2"	5/8	2-7/8	3/4	3-1/4
Z 1-1/2"x3/4"	1-1/2"	3/4	2-7/8	3/4	3-1/4
Z 1-1/2"x7/8"	1-1/2"	7/8	2-7/8	3/4	3-1/4
Z 1-1/2"x1"	1-1/2"	1	2-7/8	3/4	3-1/4
Z 1-1/2"x1-1/4"	1-1/2"	1-1/4	2-7/8	3/4	3-1/4
Z 1-3/4"x1/2"	1-3/4"	1/2	3-1/8	3/4	3-1/2
Z 1-3/4"x5/8"	1-3/4"	5/8	3-1/8	3/4	3-1/2
Z 1-3/4"x3/4"	1-3/4"	3/4	3-1/8	3/4	3-1/2
Z 1-3/4"x7/8"	1-3/4"	7/8	3-1/8	3/4	3-1/2
Z 1-3/4"x1"	1-3/4"	1	3-1/8	3/4	3-1/2
Z 1-3/4"x1-1/4"	1-3/4"	1-1/4	3-1/8	3/4	3-1/2
Z 1-3/4"x1-1/2"	1-3/4"	1-1/2	3-1/8	3/4	3-1/2
Z 2"x1/2"	2"	1/2	3-1/2	3/4	3-3/4
Z 2"x5/8"	2"	5/8	3-1/2	3/4	3-3/4
Z 2"x3/4"	2"	3/4	3-1/2	3/4	3-3/4
Z 2"x7/8"	2"	7/8	3-1/2	3/4	3-3/4

## Tool Holder Bushing Z Type 车床刀套 Z 型

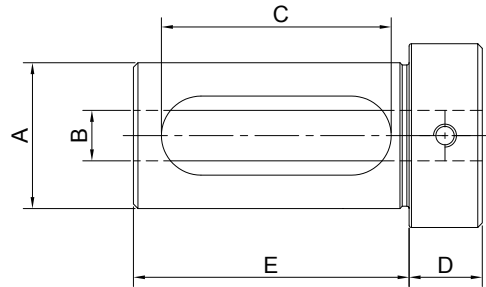

Size	A(OD)	B(ID)	C	D	Holes No.
Z 2"x1"	2"	1	3-1/2	3/4	3-3/4
Z 2"x1-1/4"	2"	1-1/4	3-1/2	3/4	3-3/4
Z 2"x1-1/2"	2"	1-1/2	3-1/2	3/4	3-3/4
Z 2"x1-3/4"	2"	1-3/4	3-1/2	3/4	3-3/4
Z 2-1/2"x5/8"	2-1/2"	5/8	3-7/8	3/4	4-1/4
Z 2-1/2"x3/4"	2-1/2"	3/4	3-7/8	3/4	4-1/4
Z 2-1/2"x7/8"	2-1/2"	7/8	3-7/8	3/4	4-1/4
Z 2-1/2"x1"	2-1/2"	1	3-7/8	3/4	4-1/4
Z 2-1/2"x1-1/4"	2-1/2"	1-1/4	3-7/8	3/4	4-1/4
Z 2-1/2"x1-1/2"	2-1/2"	1-1/2	3-7/8	3/4	4-1/4
Z 2-1/2"x1-3/4"	2-1/2"	1-3/4	3-7/8	3/4	4-1/4
Z 2-1/2"x2"	2-1/2"	2	3-7/8	3/4	4-1/4
Z 2-1/2"x2-1/4"	2-1/2"	2-1/4	3-7/8	3/4	4-1/4
Z 3"x1"	3"	1	4-3/8	3/4	4-3/4
Z 3"x1-1/4"	3"	1-1/4	4-3/8	3/4	4-3/4
Z 3"x1-1/2"	3"	1-1/2	4-3/8	3/4	4-3/4
Z 3"x1-3/4"	3"	1-3/4	4-3/8	3/4	4-3/4
Z 3"x2"	3"	2	4-3/8	3/4	4-3/4
Z 3"x2-1/4"	3"	2-1/4	4-3/8	3/4	4-3/4
Z 3"x2-1/2"	3"	2-1/2	4-3/8	3/4	4-3/4
Z 3-1/2"x1-1/4"	3-1/2"	1-1/4	4-7/8	1	5-1/2
Z 3-1/2"x1-1/2"	3-1/2"	1-1/2	4-7/8	1	5-1/2
Z 3-1/2"x1-3/4"	3-1/2"	1-3/4	4-7/8	1	5-1/2
Z 3-1/2"x2"	3-1/2"	2	4-7/8	1	5-1/2
Z 3-1/2"x2-1/4"	3-1/2"	2-1/4	4-7/8	1	5-1/2
Z 3-1/2"x2-1/2"	3-1/2"	2-1/2	4-7/8	1	5-1/2
Z 3-1/2"x3"	3-1/2"	3	4-7/8	1	5-1/2
Z 4"x1-1/2"	4"	1-1/2	5-5/8	1	6-1/4
Z 4"x1-3/4"	4"	1-3/4	5-5/8	1	6-1/4
Z 4"x2"	4"	2	5-5/8	1	6-1/4
Z 4"x2-1/4"	4"	2-1/4	5-5/8	1	6-1/4
Z 4"x2-1/2"	4"	2-1/2	5-5/8	1	6-1/4
Z 4"x3"	4"	3	5-5/8	1	6-1/4

## Tool Holder Locking Device

### 刀柄锁刀座

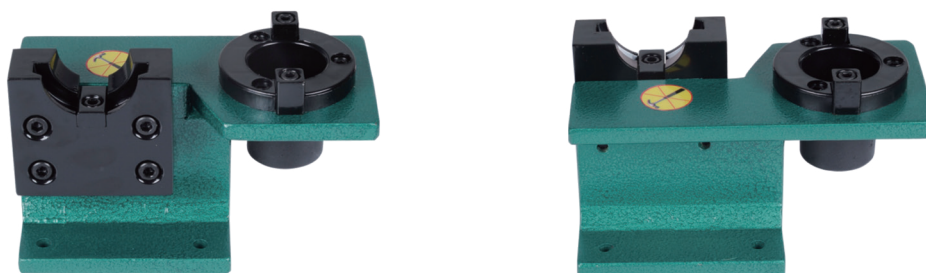

Size	Dimension (mm)	Wt (kg)
BT30	168*88*110	2.7
BT40	186*90*128	3.3
BT50	280*138*180	8.3
SK30(CAT30)	168*88*110	2.7
SK40(CAT40)	186*90*128	3.3
SK50(CAT50)	280*138*180	8.3

## Tool Holder Locking Device (New Type)

### BT\HSK\CAPTO 刀柄用 锁刀座

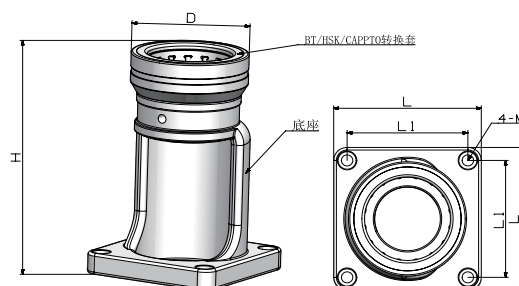

Size	Tool Holder	D	H	L	L1	M
TMS40-32	HSK32, C3	76	168	110	90	M8
TMS40-40	HSK40, C4	76	168	110	90	M8
TMS40-46	BT30	76	168	110	90	M8
TMS40-50	HSK50, SK30, C5	76	168	110	90	M8
TMS40-63	HSK63, BT40, C6	87	172	110	90	M8
TMS40-63.5	CAT40	87	172	110	90	M8
TMS40-63.55	SK40	87	172	110	90	M8
TMS50-80	HSK80, C8	114	219	160	130	M8
TMS50-97.5	SK50	124	219	160	130	M8
TMS50-98.43	CAT50	124	219	160	130	M8
TMS50-100	HSK100, BT50	124	219	160	130	M8

## HSK Coolant Tube HSK 冷却导管

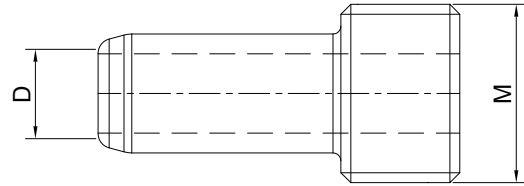

Size	Tool Holder Size	D	M	L
CT32	HSK32	6	M10×1	26
CT40	HSK40	8	M12×1	29.5
CT50	HSK50	10	M16×1	33
CT63	HSK63	12	M18×1	36.5
CT80	HSK80	14	M20×1.5	40
CT100	HSK100	16	M24×1.5	44

## Balluff Data Carrier 巴鲁夫数据芯片

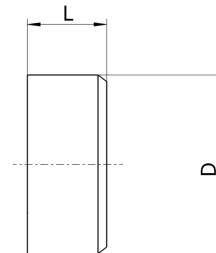

Size	D	L	Memory Type	User Data, Read/Write
BIS M-122-02/A	10	4.5	FRAM	2000 Byte
BIS C-122-04/L	10	4.5	EEPROM	511 Byte

## Clamping Kits 58 PCS

### 58 件套组合压板

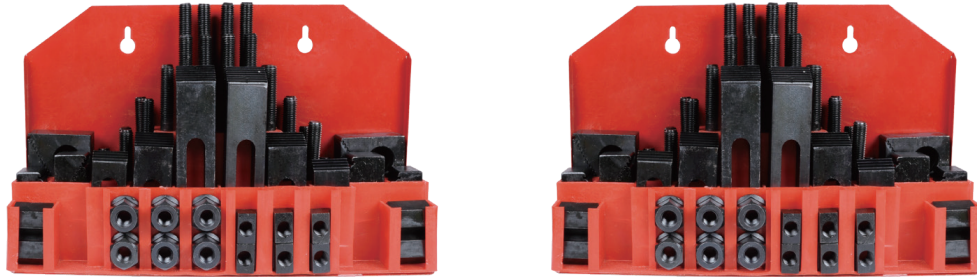

#### Metric

Size	Wt (kg)	Packing (cm)
M8*10-58 pcs	6.5kg	33*11*20
M10*12-58 pcs	7kg	33*11*20
M12*14-58 pcs	9.5kg	37*11*22
M12*16-58 pcs	10kg	37*11*22
M14*16-58 pcs	12kg	39*11*22
M14*18-58 pcs	12.5kg	39*11*22
M16*18-58 pcs	16kg	49*13*23
M16*20-58 pcs	16.5kg	49*13*23
M18*20-58 pcs	23kg	38*16*29
M20*22-58 pcs	25kg	38*16*29
M22*26-58 pcs	40kg	47*25*29

#### Inch

Size	Wt (kg)	Packing (cm)
5/16"-18*3/8"	6kg	33*11*20
3/8"-16*7/16"	7kg	33*11*20
3/8"-16*1/2"	7kg	33*11*20
3/8"-16*9/16"	7kg	33*11*20
1/2"-13-9/16"	10kg	37*11*22
1/2"-13-5/8"	10kg	37*11*22
1/2"-13-11/16"	10kg	37*11*22
5/8"-11-11/16"	16kg	39*13*23
5/8"-11-3/4"	16kg	39*13*23
5/8"-11-13/16"	16kg	39*13*23
3/4"-10*7/8"	24kg	38*16*29



## Tool Holder Trolley 刀具车



Size	Cabinet Size	Packing Size	Wt (kg)
BT30-36	920 x 475 x 775 mm	700 x 490 x 330 mm	30
BT40-36	920 x 475 x 775 mm	700 x 490 x 330 mm	31
BT50-24	920 x 475 x 775 mm	700 x 490 x 330 mm	32
HSK63-24	920 x 475 x 775 mm	700 x 490 x 330 mm	31

## Tool Holder Stand 刀架 (刀柄座)



Size	Cabinet Size	Packing Size	Wt (kg)
BT30-TS12	495 x 240 x 150 mm	525 x 270 x 180 mm	3.4
BT40-TS12	495 x 240 x 150 mm	525 x 270 x 180 mm	3.5
BT50-TS8	495 x 240 x 150 mm	525 x 270 x 180 mm	3.6
HSK63-TS8	495 x 240 x 150 mm	525 x 270 x 180 mm	3.5

## Tool Holder Cabinet 刀具柜



Size	Cabinet Size	Packing Size	Wt (kg)
BT40-TE54	650 x 405 x 1545 mm	680 x 435 x 1575 mm	53
BT40-TE54	650 x 405 x 1545 mm	680 x 435 x 1575 mm	54
BT50-TE36	650 x 405 x 1545 mm	680 x 435 x 1575 mm	55
HSK63-TE36	650 x 405 x 1545 mm	680 x 435 x 1575 mm	54

## Tool Holder Trolley (带抽屉) 刀具车



Size	Cabinet Size	Packing Size	Wt (kg)
BT30-TH54	600 x 600 x 915 mm	630 x 630 x 945 mm	63
BT40-TH54	600 x 600 x 915 mm	630 x 630 x 945 mm	64
BT50-TH36	600 x 600 x 915 mm	630 x 630 x 945 mm	65
HSK63-TH36	600 x 600 x 915 mm	630 x 630 x 945 mm	64

**Tool Holder Trolley**  
(带抽屉) 刀具车



Size	Cabinet Size	Packing Size	Wt (kg)
BT30-TL24	600 x 600 x 915 mm	630 x 630 x 945 mm	52
BT40-TL24	600 x 600 x 915 mm	630 x 630 x 945 mm	53
BT50-TL16	600 x 600 x 915 mm	630 x 630 x 945 mm	54
HSK63-TL16	600 x 600 x 915 mm	630 x 630 x 945 mm	53

**Tool Holder Trolley**  
(带抽屉) 刀具车



Size	Cabinet Size	Packing Size	Wt (kg)
BT30-TD54	600 x 600 x 1015 mm	630 x 630 x 1045 mm	72
BT40-TD54	600 x 600 x 1015 mm	630 x 630 x 1045 mm	73
BT50-TD36	600 x 600 x 1015 mm	630 x 630 x 1045 mm	74
HSK63-TD36	600 x 600 x 1015 mm	630 x 630 x 1045 mm	73

## Tool Holder Cleaning Device 除锈机



Brush Head  
清洁刷装置



Reductions  
转换环



Base Unit  
清洁机底座



Antirust Agent  
除锈剂



Power Supply  
电源适配器



Size	Taper	Base Unit	Brush Head	Brush Head D	Reduction Qty
TCD-30	BT/SK/CAT30	TCD-BU	TCD-30-BH	50	2
TCD-40	BT/SK/CAT40	TCD-BU	TCD-40-BH	63.55	2
TCD-50	BT/SK/CAT50	TCD-BU	TCD-50-BH	100	3
TCD-HSK50	HSK50	TCD-BU	TCD-HSK50-BH	50	-
TCD-HSK63	HSK63	TCD-BU	TCD-HSK63-BH	63	-
TCD-HSK100	HSK100	TCD-BU	TCD-HSK100-BH	100	-

All tool holders use the same base unit, only to change the brush head for different tapers.  
Included reduction rings to be used with the brush head for toolholders according different taper standards.

- TCD-30: two reduction rings, one for SK30 tool holders, the other one for BT30 and CAT30.
- TCD-40: two reduction rings, one for BT40 tool holders, the other one for SK40 and CAT40.
- TCD-50: three reduction rings for BT50, SK50 and CAT50 tool holders.
- HSK cleaning devices are used for Form A/C/D/E/F, without reductions.

刀柄清洁器底座通用，根据锥柄不同选配不同的清洁刷装置。  
随附的转换环与不同锥柄的清洁刷装置一起使用。

- TCD-30: 随附两个转换环，一个供 SK30 使用，另一个 BT30 和 CAT30 通用。
- TCD-40: 随附两个转换环，一个供 BT40 使用，另一个 SK40 和 CAT40 通用。
- TCD-50: 随附三个转换环，分别用于 BT50, SK50 和 CAT50。
- HSK 系列清洁器不配转换环，适用类型 A/C/D/E/F。